

# TOSHIBA



# DVD VIDEO PLAYER **SD-240ESE** **SD-240ESB**

## OWNER'S MANUAL



Introduction 2

Connections 18

Basic playback 26

Advanced playback 34

Function setup 51

Others 60



# SAFETY PRECAUTIONS

**WARNING:** TO REDUCE THE RISK OF FIRE OR ELECTRIC SHOCK, DO NOT EXPOSE THIS APPLIANCE TO RAIN OR MOISTURE. DANGEROUS HIGH VOLTAGES ARE PRESENT INSIDE THE ENCLOSURE. DO NOT OPEN THE CABINET. REFER SERVICING TO QUALIFIED PERSONNEL ONLY.

**CAUTION:** This Digital Video Disc Player employs a Laser System. To ensure proper use of this product, please read this owner's manual carefully and retain for future reference. Should the unit require maintenance, contact an authorized service location - see service procedure.

Use of controls of adjustments or performance of procedures other than those specified herein may result in hazardous radiation exposure.

To prevent direct exposure to laser beam, do not try to open the enclosure. Visible and invisible laser radiation when open and interlocks defeated. DO NOT STARE INTO BEAM.



In the spaces provided below, record the Model and Serial No. located on the rear panel of your DVD player.

Model No. \_\_\_\_\_ Serial No. \_\_\_\_\_

Retain this information for future reference.

The following information applies only to the model for U.K.

**General Information**

If the socket outlets in your home are not suitable for the plug supplied with this unit, the plug must be cut off and an appropriate one fitted.

The plug severed from this mains lead must be destroyed as it is hazardous if inserted into a live socket.

**IMPORTANT**  
*The wires in this mains lead are coloured in accordance with the following code:*  
**BLUE: NEUTRAL**  
**BROWN: LIVE**  
*As the colours of the wires in the mains lead of this unit may not correspond with the coloured markings identifying the terminals in your plug, proceed as follows:*  
*The wire that is coloured blue must be connected to the terminal in the plug which is marked with the letter N or coloured black.*  
*The wire that is coloured brown must be connected to the terminal which is marked with the Letter L or coloured red.*

Do not connect either wire to the earth terminal which is marked by the letter E or by the safety earth symbol  $\perp$  or coloured green or green-and-yellow.

Use a 5A fuse which is approved by ASTA or BSI to BS1362.  
Always replace the fuse cover after changing the fuse.

## Location of the required label

The rating plate and the safety caution are on the rear of the unit.

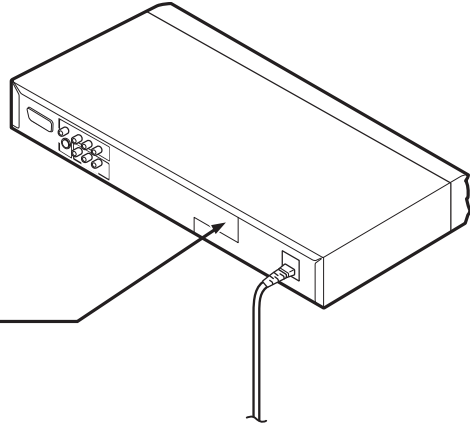

# IMPORTANT SAFETY INSTRUCTIONS

---

**CAUTION: PLEASE READ AND OBSERVE ALL WARNINGS AND INSTRUCTIONS GIVEN IN THIS OWNER'S MANUAL AND THOSE MARKED ON THE UNIT. RETAIN THIS BOOKLET FOR FUTURE REFERENCE.**

This set has been designed and manufactured to assure personal safety. Improper use can result in electric shock or fire hazard. The safeguards incorporated in this unit will protect you if you observe the following procedures for installation, use and servicing. This unit is fully transistorized and does not contain any parts that can be repaired by the user.

**DO NOT REMOVE THE CABINET COVER, OR YOU MAY BE EXPOSED TO DANGEROUS VOLTAGE. REFER SERVICING TO QUALIFIED SERVICE PERSONNEL ONLY.**

1. Read these instructions.
2. Keep these instructions.
3. Heed all warnings.
4. Follow all instructions.
5. Do not use this apparatus near water.
6. Clean only with dry cloth.

7. Do not block any ventilation openings. Install in accordance with the manufacturer's instructions.
  
8. Do not install near any heat sources such as radiators, heat registers, stoves, or other apparatus (including amplifiers) that produce heat.
  
9. Protect the power cord from being walked on or pinched particularly at plugs, convenience receptacles, and the point where they exit from the apparatus.
  
10. Only use attachments/accessories specified by the manufacturer.

11. Use only with the cart, stand, tripod, bracket, or table specified by the manufacturer, or sold with the apparatus. When a cart is used, use caution when moving the cart/apparatus combination to avoid injury from tip-over.



12. Unplug this apparatus during lightning storms or when unused for long periods of time.

# IMPORTANT SAFETY INSTRUCTIONS

---

13. Refer all servicing to qualified service personnel. Servicing is required when the apparatus has been damaged in any way, such as power-supply cord or plug is damaged, liquid has been spilled or objects have fallen into the apparatus, the apparatus has been exposed to rain or moisture, does not operate normally, or has been dropped.

## **ADDITIONAL SAFETY INSTRUCTIONS**

---

14. When you use headphones, keep the volume at a moderate level. If you use the headphones continuously with high volume sound, it may cause hearing damage.

15. Do not overload wall outlets; extension cords, or integral convenience receptacles as this can result in a risk of fire or electric shock.

16. Apparatus shall not be exposed to dripping or splashing and no objects filled with liquids, such as vases, shall be placed on the apparatus.

17. Keep your fingers well clear of the disc tray as it is closing. Neglecting to do so may cause serious personal injury.

---

18. Do not place a heavy object on or step on the apparatus. The object may fall, causing serious personal injury and serious damage to the apparatus.

19. Do not use a cracked, deformed, or repaired disc. These discs are easily broken and may cause serious personal injury and apparatus malfunction.

## Precautions

### Notes on handling

- When shipping the DVD video player, the original shipping carton and packing materials come in handy. For maximum protection, repack the unit as it was originally packed at the factory. Take care not to give it a shock or shake when carrying.
- Do not use volatile liquids, such as insect spray, near the DVD video player. Do not leave rubber or plastic products in contact with the DVD video player for a long time. They will leave marks on the finish.
- The top and rear panels of the DVD video player may become warm after a long period of use. This is not a malfunction.
- When the DVD video player is not in use, be sure to remove the disc and turn off the power.
- If you do not use the DVD video player for a long period, the unit may not function properly in the future. Turn on and use the DVD video player occasionally.

### Notes on locating

- Place the DVD video player on a level surface. Do not use it on a shaky or unstable surface such as a wobbling table or inclined stand. The loaded disc may come off the proper position and cause damage to the DVD video player.
- When you place this DVD video player near a TV, radio, or VCR, the playback picture may become poor and the sound may be distorted. In this case, place the DVD video player away from the TV, radio, or VCR.

### Notes on cleaning

Use a soft, dry cloth for cleaning.

- For stubborn dirt, soak the cloth in a weak detergent solution, wring well and wipe. Use a dry cloth to wipe it dry.  
Do not use any type of solvent, such as thinner and benzene, as they may damage the surface of the DVD video player.
- If you use a chemical saturated cloth to clean the unit, follow that product's instructions.

### To obtain a clear picture

The DVD video player is a high technology, precision device. If the optical pick-up lens and disc drive parts are dirty or worn down, the picture quality becomes poor. To obtain a clear picture, we recommend regular inspection and maintenance (cleaning or parts replacement) every 1,000 hours of use depending on the operating environment. For details, contact your nearest dealer.

### Notes on moisture condensation

#### Moisture condensation damages the DVD video player. Please read the following carefully.

Moisture condensation occurs, for example, when you pour a cold drink into a glass on a warm day. Drops of water form on the outside of the glass. In the same way, moisture may condense on the optical pick-up lens inside this unit, one of the most crucial internal parts of the DVD video player.

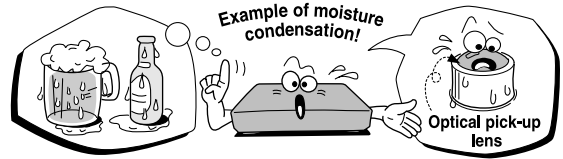

#### Moisture condensation occurs during the following cases.

- When you bring the DVD video player directly from a cold place to a warm place.
- When you use the DVD video player in a room where you just turned on the heater, or a place where the cold wind from the air conditioner directly hits the unit.
- In summer, when you use the DVD video player in a hot and humid place just after you move the unit from an air conditioned room.
- When you use the DVD video player in a humid place.

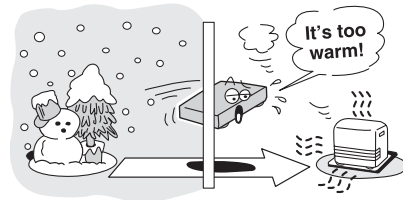

#### Do not use the DVD video player when moisture condensation may occur.

If you use the DVD video player in such a situation, it may damage discs and internal parts. Remove the disc, connect the power cord of the DVD video player to the wall outlet, turn on the DVD video player, and leave it for two or three hours. After two or three hours, the DVD video player will have warmed up and evaporated any moisture. Keep the DVD video player connected to the wall outlet and moisture condensation will seldom occur.

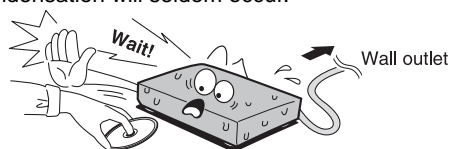



# Notes on Discs

## On handling discs

- Do not touch the playback side of the disc.

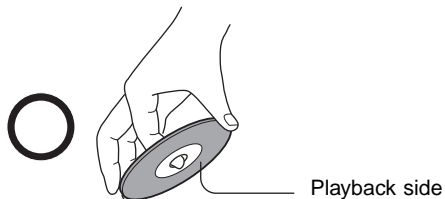

- Do not attach paper or tape to discs.



## On cleaning discs

- Fingerprints and dust on the disc cause picture and sound deterioration. Wipe the disc from the center outwards with a soft cloth. Always keep the disc clean.

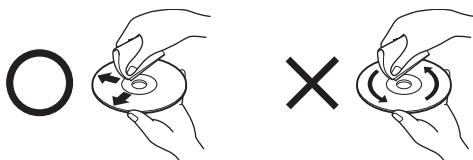

- If you cannot wipe off the dust with a soft cloth, wipe the disc lightly with a slightly moistened soft cloth and finish with a dry cloth.
- Do not use any type of solvent such as thinner, benzene, commercially available cleaners or antistatic spray for vinyl LPs. It may damage the disc.

## On storing discs

- Do not store discs in a place subject to direct sunlight or near heat sources.
- Do not store discs in places subject to moisture and dust such as a bathroom or near a humidifier.
- Store discs vertically in a case. Stacking or placing objects on discs outside of their case may cause warping.

## Structure of disc contents

Normally, DVD video discs are divided into titles, and the titles are sub-divided into chapters. VIDEO CDs and audio CDs are divided into tracks.

DVD video disc

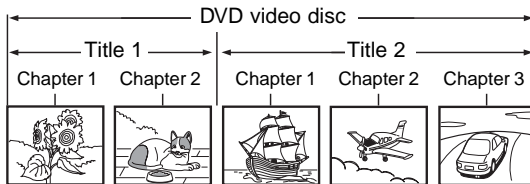

VIDEO CD/audio CD

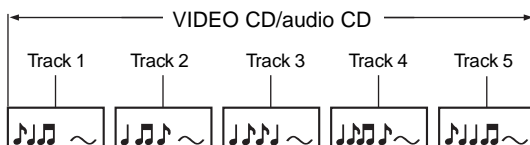

Each title, chapter or track is assigned a number, which is called "title number", "chapter number" or "track number" respectively.

There may be discs that do not have these numbers.

## Notes on copyright

It is forbidden by law to copy, broadcast, show, broadcast on cable, play in public, and rent copyrighted material without permission.

DVD video discs are copy protected, and any recordings made from these discs will be distorted.

This product incorporates copyright protection technology that is protected by method claims of certain U.S. patents and other intellectual property rights owned by Macrovision Corporation and other rights owners. Use of this copyright protection technology must be authorized by Macrovision Corporation, and is intended for home and other limited viewing uses only unless otherwise authorized by Macrovision Corporation. Reverse engineering or disassembly is prohibited.



## Notes on Discs (continued)

### About this owner's manual

This owner's manual explains the basic instructions of this DVD video player. Some DVD video discs are produced in a manner that allows specific or limited operation during playback. As such, the DVD video player may not respond to all operating commands. This is not a defect in the DVD video player. Refer to instruction notes of discs.

"⊘" may appear on the TV screen during operation. A "⊘" means that the operation is not permitted by the DVD video player or the disc.

### Notes on region numbers

The region number of this DVD video player is 2. If region numbers, which stand for their playable area, are printed on your DVD video disc and you do not find  or , disc playback will not be allowed by the player. (In this case, the DVD video player will display a message on-screen.)

### On VIDEO CDs

This DVD video player supports VIDEO CDs equipped with the PBC (Version 2.0) function. (PBC is the abbreviation of Playback Control.) You can enjoy two playback variations depending on types of discs.

- **VIDEO CD not equipped with PBC function (Version 1.1)**



Sound and movie can be played on this DVD video player in the same way as an audio CD.

- **VIDEO CD equipped with PBC function (Version 2.0)**

In addition to operation of a VIDEO CD not equipped with the PBC function, you can enjoy playback of interactive software with search function by using the menu displayed on the TV screen (Menu Playback). Some of the functions described in this owner's manual may not work with some discs.

### Playable discs

This DVD video player can play the following discs.

	Disc Mark	Contents	Disc Size	Maximum playback time
DVD video discs		Audio + video (moving pictures)	12 cm	Approx. 4 hours (single sided disc)
				Approx. 8 hours (double sided disc)
			8 cm	Approx. 80 minutes (single sided disc)
				Approx. 160 minutes (double sided disc)
VIDEO CDs		Audio + video (moving pictures)	12 cm	Approx. 74 minutes
			8 cm	Approx. 20 minutes
Audio CDs		Audio	12 cm	Approx. 74 minutes
			8 cm (CD single)	Approx. 20 minutes
<p>The following discs are also available.</p> <ul style="list-style-type: none"> <li>● DVD-R discs of DVD video format</li> <li>● CD-R/CD-RW discs of CD-DA format</li> </ul> <p>Some of these discs may be incompatible.</p>				

- You cannot play discs other than those listed above.
- You cannot play DVD-RAM discs or non-standardized discs, etc., even if they may be labeled as above.
- This DVD video player uses the PAL/NTSC color system, and cannot play DVD video discs recorded in any other color system (SECAM, etc.).

# Table of Contents

## Introduction

● SAFETY PRECAUTIONS .....	2
● IMPORTANT SAFETY INSTRUCTIONS ...	4
● Precautions .....	8
● Notes on Discs .....	9
Notes on region numbers .....	10
● Table of Contents .....	11
● Identification of Controls .....	12
Front panel .....	12
Rear panel .....	13
Remote control .....	14
Loading batteries .....	15
Operating with the remote control .....	15

## Connections

● Connecting to a TV .....	18
Connecting to a TV (Using the SCART socket) .....	18
Connecting to a TV (Using the phono type jacks) .....	18
Connecting to a TV (Using the component video jacks) .....	19
● Connecting to Optional Equipment .....	20
Connecting to an amplifier equipped with a Dolby Digital decoder .....	21
Connecting to an amplifier equipped with Dolby Surround Pro Logic .....	21
Connecting to an amplifier equipped with a DTS decoder .....	22
Connecting to an amplifier equipped with an MPEG2 audio decoder .....	22
Connecting to an amplifier equipped with a digital audio input .....	23

## Basic playback

● Playing a Disc .....	26
Basic playback .....	26
● Variable Speed Playback .....	28
Playing in fast reverse or fast forward directions .....	28
Playing frame by frame .....	28
Playing in slow-motion .....	29
Resuming playback from the same location ..	29
● Locating a Desired Section .....	30
Locating a title using the top menu .....	30
Locating a desired section by entering the corresponding number .....	31
Locating a specific chapter or track .....	31

## Advanced playback

● Accessing a Specific Location Directly ...	34
Entering the time counter of the desired location .....	34
● Repeating a Specific Segment .....	34
Repeating a specific segment .....	34
● Playing in a Varied Order .....	35
Playing titles, chapters or tracks in a varied order .....	35
● Playing in a Favourite Order .....	36
Setting titles, chapters, or tracks in a favourite order .....	36
● Zooming a Picture .....	37
Zooming a picture .....	37
● Selecting the Picture Enhancement (E.P.M.) .....	38
Selecting the picture enhancement .....	38
● Selecting the Sound Enhancement (E.A.M.) .....	39
Selecting the sound enhancement .....	39
● Selecting the Camera Angle .....	40
Changing the camera angle .....	40
● Selecting Subtitles .....	41
Selecting a subtitle language .....	41
● Selecting a Language .....	42
Selecting a playback audio setting .....	42
● On-screen Display Operation .....	44
On-screen display operation .....	44
● Playing MP3/WMA Files .....	46
Playing MP3/WMA files .....	46
● Viewing JPEG Files .....	48
Starting from a thumbnail view .....	48

## Function setup

● Customizing the Function Settings .....	51
Setting procedure .....	52
Setting details .....	54
● Table of Languages .....	59

## Others

● Before Calling Service Personnel .....	60
● Specifications .....	63

# Identification of Controls

See the page in   for details.

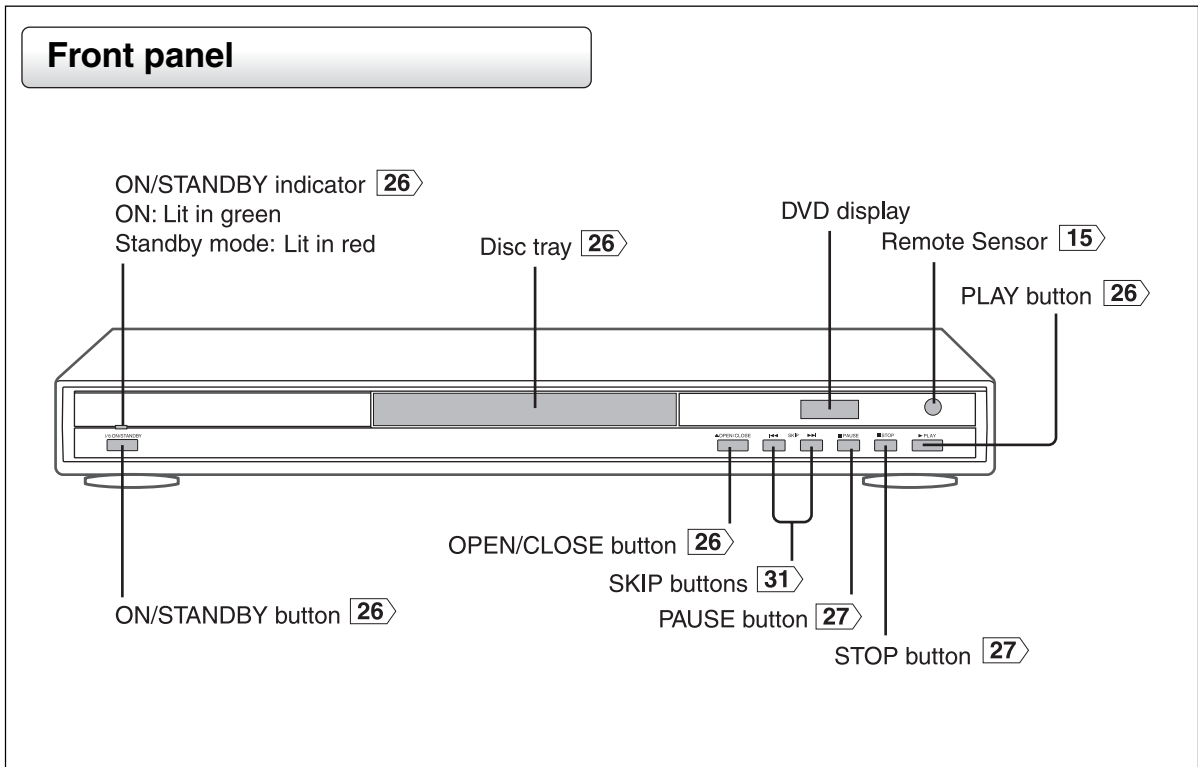

## Rear panel

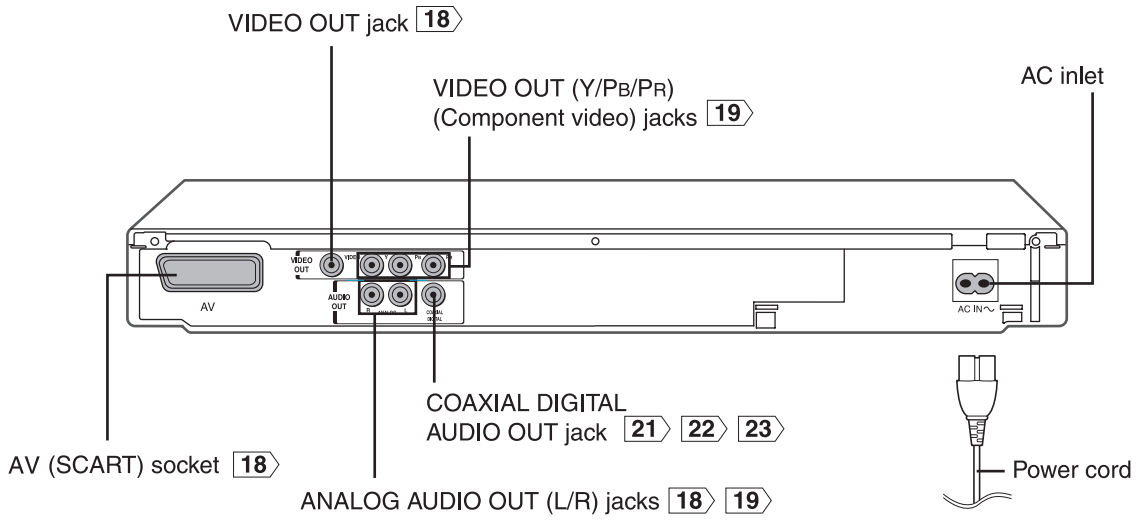

# Identification of Controls (continued)

The instructions in this manual describe the functions on the remote control. See the page in    for details.

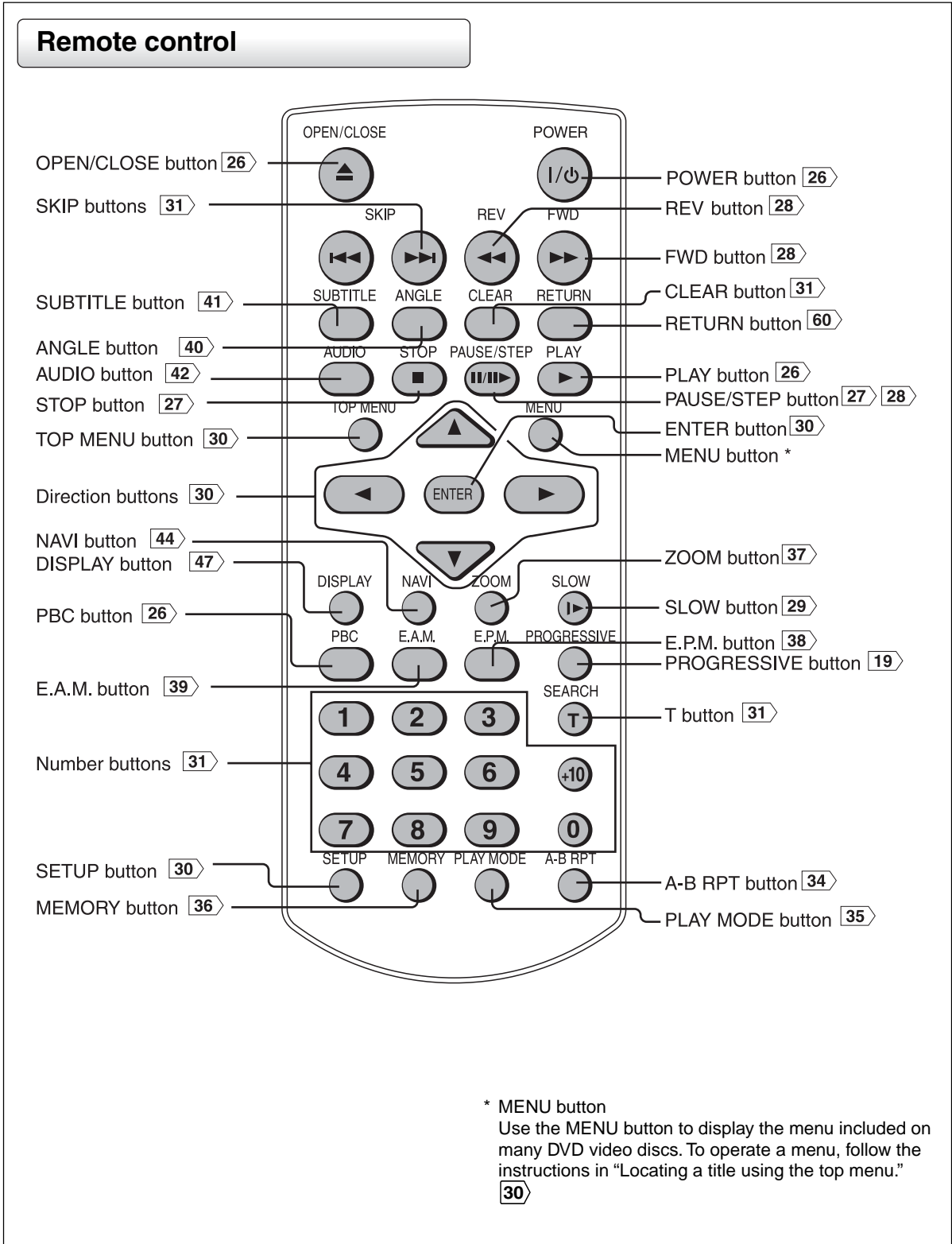

## Loading batteries

### 1 Open the cover.

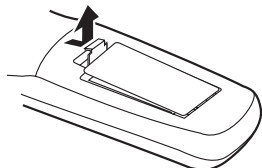

### 2 Insert batteries (R03 size).

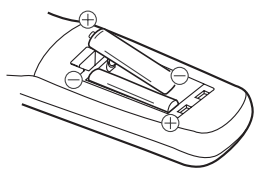

Make sure to match the + and – on the batteries to the marks inside the battery compartment.

## Operating with the remote control

### Point the remote control at the remote sensor and press the buttons.

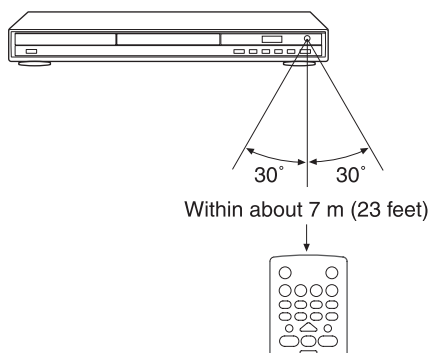

Distance: About 7 m (23 feet) from the front of the remote sensor

Angle: About 30° in each direction of the front of the remote sensor

\* Do not expose the remote sensor of the DVD video player to a strong light source such as direct sunlight or other illumination. If you do so, you may not be able to operate the DVD video player via the remote control.

### Notes on batteries

Improper use of batteries may cause battery leakage and corrosion. To operate the remote control correctly, follow the instructions below.

- Do not insert batteries into the remote control in the wrong direction.
- Do not charge, heat, open, or short-circuit the batteries. Do not throw batteries into a fire.
- Do not leave dead or exhausted batteries in the remote control.
- Do not use different types of batteries together, or mix old and new batteries.
- If you do not use the remote control for a long period of time, remove the batteries to avoid possible damage from battery corrosion.
- If the remote control does not function correctly or if the operating range becomes reduced, replace all batteries with new ones.
- If battery leakage occurs, wipe the battery liquid from the battery compartment, then insert new batteries.

### Notes on the remote control

- Direct the remote control at the remote sensor of the DVD video player.
- Do not drop or give the remote control a shock.
- Do not leave the remote control near an extremely hot or humid place.
- Do not spill water or put anything wet on the remote control.
- Do not open the remote control.

# Connections

Read this chapter first to make all necessary preparations.

- **Connecting to a TV  
(Using the SCART socket)**
- **Connecting to a TV  
(Using the phone type jacks)**
- **Connecting to a TV  
(Using the component video jacks)**
- **Connecting to an amplifier  
equipped with a Dolby Digital  
decoder**
- **Connecting to an amplifier  
equipped with Dolby Surround  
Pro Logic**
- **Connecting to an amplifier  
equipped with a DTS decoder**
- **Connecting to an amplifier  
equipped with an MPEG2 audio  
decoder**
- **Connecting to an amplifier  
equipped with a digital audio  
input**



# Connecting to a TV

Connect the DVD video player to your TV.  
 For details of output sound, see **43**.

## Connecting to a TV (Using the SCART socket)

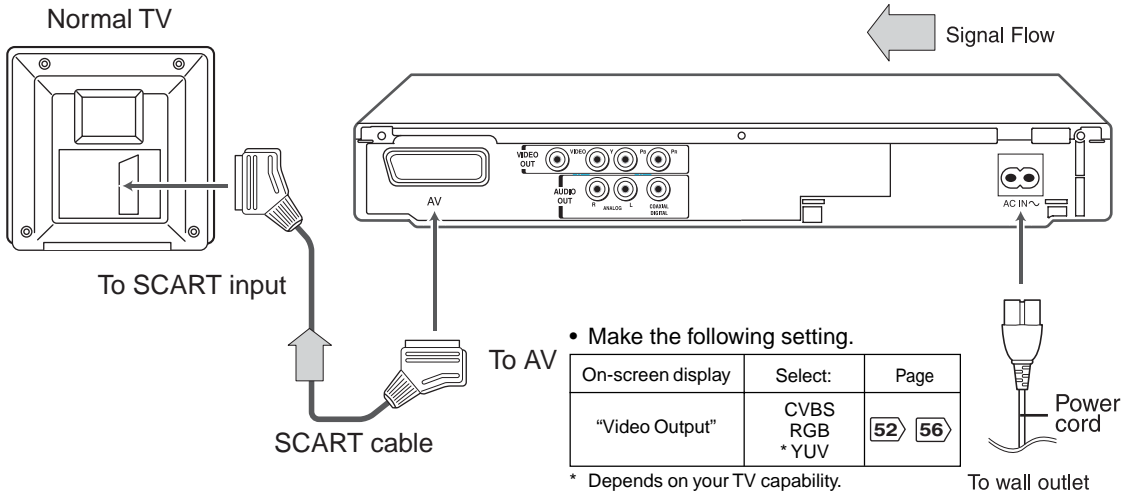

## Connecting to a TV (Using the phono type jacks)

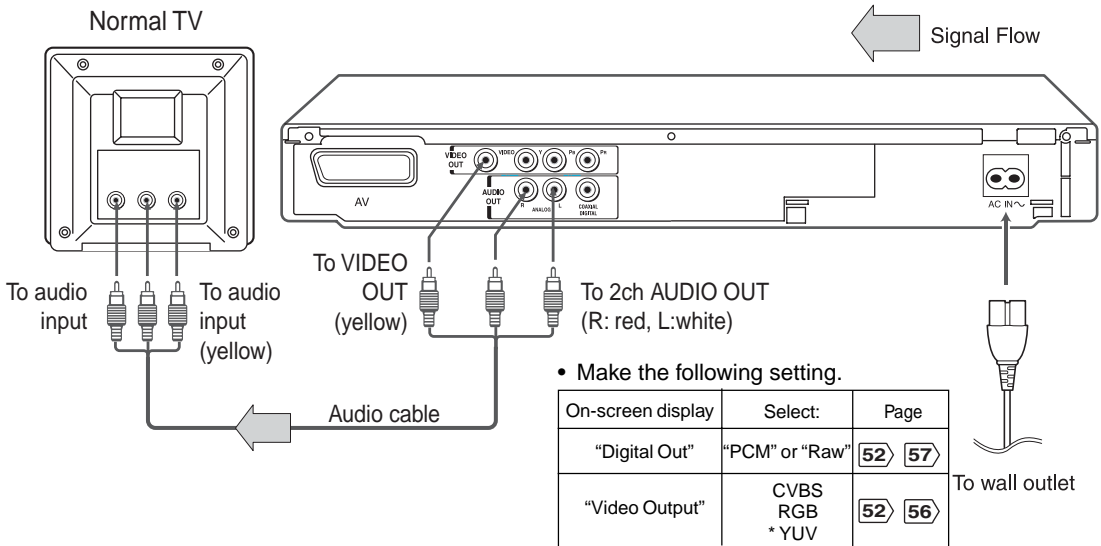

**Notes**

- Refer to the owner's manual of the connected TV as well.
- When you connect the DVD video player to your TV, be sure to turn off the power and unplug both units from the wall outlet before making any connections.
- If your television set has one audio input, connect the left and right audio outputs of the DVD video player to a Y cable adapter (not supplied) and then connect to your TV.
- Connect the DVD video player directly to your TV. If you connect the DVD video player to a VCR, TV/VCR combination or video selector, the playback picture may be distorted as DVD video discs are copy protected.
- Analog audio out will not have sound if DTS playback is selected.

**Interlaced outputs/inputs**

Some TVs or monitors are equipped with component video inputs. Connecting to these inputs allows you to enjoy higher quality picture playback.

Actual labels for component video inputs may vary depending on the TV manufacturer. (ex. Y, R-Y, B-Y or Y, Cb, Cr)

In some TVs or monitors, the color levels of the playback picture may be reduced slightly or the tint may change. In such a case, adjust the TV or monitor for optimum performance.

**Progressive outputs/inputs**

Some TVs or monitors are equipped with component video inputs that are capable of reproducing a progressively scanned video signal. Connecting to these inputs allows you to view the highest quality pictures with less flicker.

Consumers should note that not all high definition television sets are fully compatible with this product and may cause artifacts to be displayed in the picture. In case of 525 or 625 progressive scan picture problems, it is recommended that the user switch the connection to the “standard definition” output. If there are questions regarding our TV set compatibility with this model 525p and 625p DVD player, please contact our customer service center.

**Connecting to a TV (Using the component video jacks)**

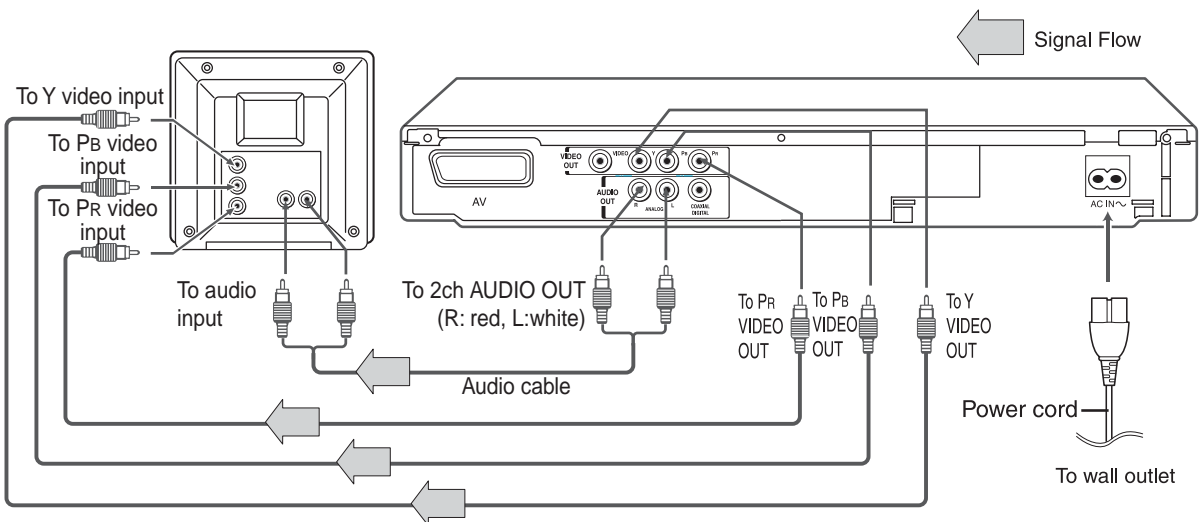

**Switching the output signal (interlaced/progressive) using the remote control**

You can temporarily switch the output signal for better picture quality.

Press **PROGRESSIVE** on the remote control during stop.

Press **PROGRESSIVE** again to turn off progressive mode.

• Make the following setting.

On-screen display	Select:	Page
"Digital Out"	"PCM" or "Raw"	[52] [57]
"Video Output"	YUV	[52] [56]

**Notes**

- Refer to the owner's manual of the connected equipment as well.
- When you connect the DVD video player to other equipment, be sure to turn off the power and unplug all of the equipment from the wall outlet before making any connections.
- If you place the DVD video player near a tuner or radio, the radio broadcast sound might be distorted. In this case, place the DVD video player away from the tuner and radio.
- The output sound of the DVD video player has a wide dynamic range. Be sure to adjust the receiver's volume to a moderate listening level. Otherwise, high volume sound may damage your hearing as well as the speakers.
- Turn off the amplifier before you connect or disconnect the DVD video player's power cord. If you leave the amplifier power on, the speakers may be damaged.
- Progressive can be on/off only when video output is set to YUV. [56]
- When Progressive is on, only component video will be output.
- When the TV system is set to PAL mode, the progressive output will be forced to 625p. [56]
- Analog audio out will not have sound if DTS playback is selected.

## Connecting to Optional Equipment

You can enjoy high quality dynamic sounds by connecting the DVD video player to optional audio equipment.

- For connection to your TV, see “Connecting to a TV” [18](#) [19](#).
- For details of output sound, see [43](#).
- This section uses the following reference marks.

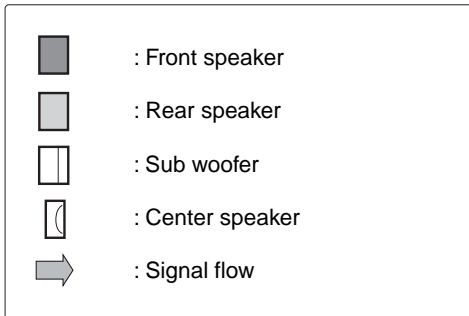

### Notes

- DO NOT connect the COAXIAL DIGITAL AUDIO OUT jack of the DVD video player to the AC-3 RF input of a Dolby Digital Receiver. This input on your A/V Receiver is reserved for Laserdisc use only and is incompatible with the COAXIAL DIGITAL AUDIO OUT jack of the DVD video player.
- Connect the COAXIAL DIGITAL AUDIO OUT jack of the DVD video player to the “DIGITAL (COAXIAL)” input of a Receiver or Processor.
- Refer to the owner’s manual of the connected equipment as well.
- When you connect the DVD video player to other equipment, be sure to turn off the power and unplug all of the equipment from the wall outlet before making any connections.
- The output sound of the DVD video player has a wide dynamic range. Be sure to adjust the receiver’s volume to a moderate listening level. Otherwise, the speakers may be damaged by a sudden high volume sound.
- Turn off the amplifier before you connect or disconnect the DVD video player’s power cord. If you leave the amplifier power on, the speakers may be damaged.

### Warning

- When you are connecting (via the COAXIAL DIGITAL AUDIO OUT jack) an AV decoder that does not have Dolby Digital, Digital Theater Systems (DTS) or MPEG2 decoding function, be sure to set “Digital Out” to “PCM” from the on-screen displays [52](#) [57](#). Otherwise, high volume sound may damage your hearing as well as the speakers.
- When playing DTS-encoded discs (audio CDs), excessive noise may be output from the analog audio output jacks. To avoid possible damage to the audio system, you should take proper precautions when the analog audio output jacks of the DVD video player are connected to an amplification system. To enjoy DTS Digital Surround™ playback, an external 5.1 channel DTS Digital Surround™ decoder system must be connected to the COAXIAL DIGITAL AUDIO OUT jack of the DVD video player.

## Connecting to an amplifier equipped with a Dolby Digital decoder

### Dolby Digital

Dolby Digital is the surround sound technology used in theaters showing the latest movies, and is now available to reproduce this realistic effect in the home. You can enjoy motion picture and live concert DVD video discs with this dynamic realistic sound by connecting the DVD video player to a 6 channel amplifier equipped with a Dolby Digital decoder or Dolby Digital processor. If you have a Dolby Surround Pro Logic decoder, you will obtain the full benefit of Pro Logic from the same DVD movies that provide full 5.1-channel Dolby Digital soundtracks, as well as from titles with the Dolby Surround mark.

Manufactured under license from Dolby Laboratories. "Dolby", "Pro Logic" and the double-D symbol are trademarks of Dolby Laboratories. Confidential unpublished works. Copyright 1992-1997 Dolby Laboratories. All rights reserved.

- Use DVD video discs encoded via the Dolby Digital recording system.
- Make the following setting.

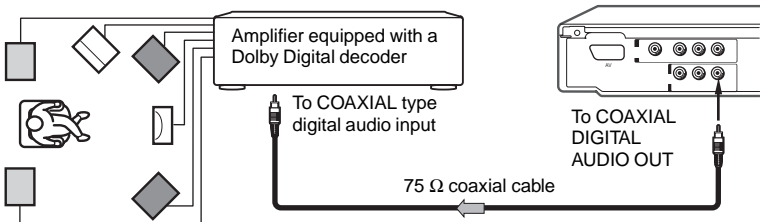

On-screen display	Select:	Page
"Digital Out"	"Raw" or "PCM"	52 57
Recording system	D	43

## Connecting to an amplifier equipped with Dolby Surround Pro Logic

### Dolby Surround Pro Logic

You can enjoy the dynamic realistic sound of Dolby Surround Pro Logic by connecting an amplifier and speaker system (right and left front speakers, a center speaker, and one or two rear speakers).

- With an amplifier equipped with Dolby Digital  
Connect the equipment the same way as described in "Connecting to an amplifier equipped with a Dolby Digital decoder." Refer to that amplifier's owner's manual and set the amplifier so you can enjoy Dolby Surround Pro Logic sound.
- With an amplifier not equipped with Dolby Digital  
Connect the equipment as follows.

- Make the following setting.

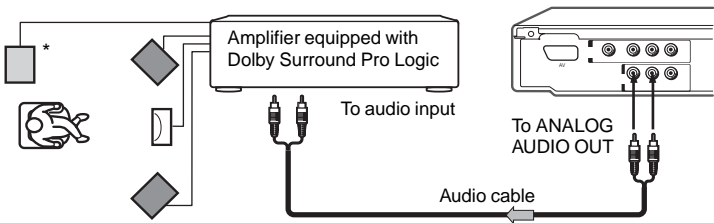

On-screen display	Select:	Page
"Digital Out"	"Raw" or "PCM"	52 57

\* Connect one or two rear speakers. The output sound from the rear speakers will be monaural even if you connect two rear speakers.

# Connecting to Optional Equipment (Continued)

## Connecting to an amplifier equipped with a DTS decoder

### Digital Theater Systems (DTS)

DTS is a high quality surround technology used in theaters and now available for home use, on DVD video discs or audio CDs.

If you have a DTS decoder or processor, you can obtain the full benefit of 5.1 channel DTS encoded sound tracks on DVD video discs or audio CDs.

"DTS" and "DTS Digital Out" are trademarks of Digital Theater Systems, Inc.

- Use DVD video discs or audio CDs encoded via the DTS recording system.
- Make the following setting.

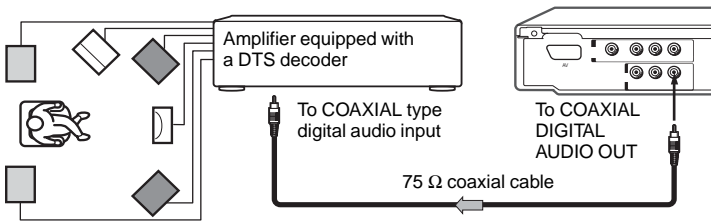

On-screen display	Select:	Page
"Digital Out"	"Raw"	52
		57
Recording system	DTS	43

## Connecting to an amplifier equipped with an MPEG2 audio decoder

### MPEG2 sound

You can enjoy motion picture and live concert DVD video discs with dynamic realistic sound by connecting an amplifier equipped with an MPEG2 audio decoder or MPEG2 audio processor.

- Use DVD video discs encoded via the MPEG2 recording system.
- Make the following setting.

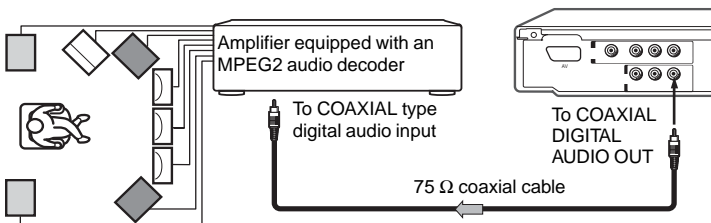

On-screen display	Select:	Page
"Digital Out"	"Raw" or "PCM"	52
		57
Recording system	MPEG2	43

## Connecting to an amplifier equipped with a digital audio input

### 2 channel digital stereo

You can enjoy the dynamic sound of 2 channel digital stereo by connecting an amplifier equipped with a digital audio input and speaker system (right and left front speakers).

- Make the following setting.

On-screen display	Select:	Page
"Digital Out"	"PCM"	52
		57

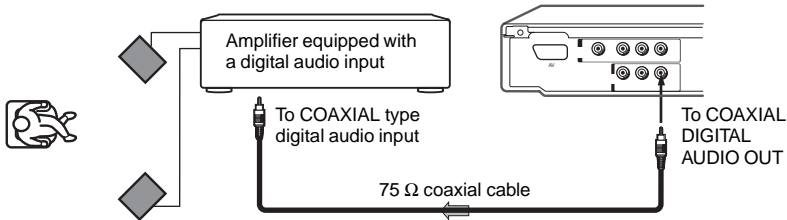

# **Basic playback**

Begin your operation.

- **Playing a Disc**
- **Variable Speed Playback**
- **Locating a Desired Section**

## Playing a Disc

This section shows you the basics on how to play a disc.

### CAUTION

Keep your fingers well clear of the disc tray as it is closing. Neglecting to do so may cause serious personal injury.

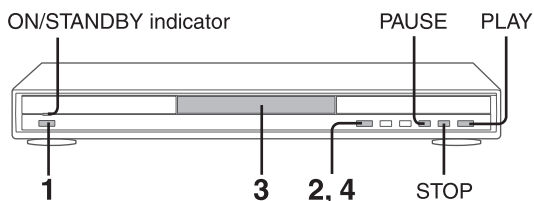

## Basic playback

### Preparations

- When you want to view a disc, turn on the TV and select the video input connected to the DVD video player.
- When you want to enjoy the sound of discs from the audio system, turn on the audio system and select the input connected to the DVD video player.

### 1 Press the POWER button.

**POWER** The DVD video player turns on.  
The ON/STANDBY indicator on the player turns green.



**When the DVD video player is turned on for the first time, an on-screen display will appear to provide initial settings. Press the ▲/▼ buttons to select an item, and press the ENTER button. Make a selection using the ▲/▼ buttons, then press the ENTER button.**

**On-Screen Language** [54](#)

**TV Shape** [56](#)

### 2 Press OPEN/CLOSE.

**OPEN/CLOSE** The disc tray opens.



### 3 Place the disc on the disc tray.

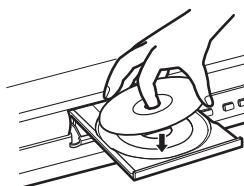

With the playback side down

- There are two different disc sizes. Place the disc in the correct guide on the disc tray. If the disc is out of the guide, it may damage the disc and cause the DVD video player to malfunction.
- Do not place a disc which is unplayable in this DVD video player.

### 4 Press OPEN/CLOSE to close the disc tray.

**OPEN/CLOSE** Playback starts.



If you insert a DVD video disc that contains a top menu, a menu may appear. Use the ▲/▼/◀/▶ to select the title you want to view, then press ENTER to start playback. See "Locating a title using the top menu" [30](#).

- You may need to press the TOP MENU or MENU button to display disc menu (depending on the actual DVD video disc.)

### Note

- If the disc tray is holding a disc you have already played, playback will begin from the location where you last stopped. For resuming playback, see [29](#).
- Some Video CD are recorded with **PBC (Playback Control)**, a menu with recorded contents may appear on the TV if you have turned the PBC on. You can make your selection according to its PBC menu. Press the **PBC** button on the remote control to turn PBC on and off anytime during you are playing back a Video CD.

### ■ To start playback in the stop mode

Press **PLAY**.





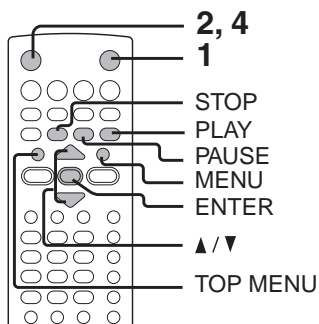

■ **To obtain a higher quality picture**

Occasionally, some picture noise not usually visible during a normal broadcast may appear on the TV screen while playing a DVD video disc because the high resolution pictures on these discs include a lot of information. While the amount of noise depends on the TV you use with this DVD video player, you should generally reduce the sharpness adjustment on your TV when viewing DVD video discs.

■ **About DVD VCD CD**

The DVD VCD CD icons on the heading bar show the playable discs for the function described under that heading.

DVD : You can use this function with DVD video discs.

VCD : You can use this function with VIDEO CDs.

CD : You can use this function with audio CDs.

■ **To pause playback (still mode)**

Press **PAUSE/STEP** during playback.



To resume normal playback, press the **PLAY** button.

- The sound is muted during still mode.

■ **To stop playback**

Press **STOP**.

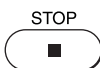

■ **To remove the disc**

Press **OPEN/CLOSE**.



Remove the disc after the disc tray opens completely.

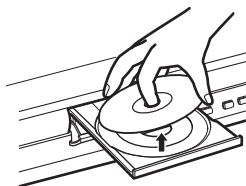

Be sure to press the **OPEN/CLOSE** button to close the disc tray after you remove the disc.

■ **To turn the power off (To enter the standby mode)**

Press **POWER** button to turn the ON/STANDBY indicator to red.

**Note**

Be aware that this equipment is still powered even after the ON/STANDBY indicator turns red (standby mode) by pressing the **POWER** button. To disconnect this equipment completely from the mains power, pull out the power plug from the wall outlet.

■ **About the screen saver**

If you pause a picture of a DVD video disc and leave it still for a long while, the screen saver of the DVD video player automatically appears. To turn off the screen saver, press the **PLAY** button.

■ **Automatic Power Off function**

If the DVD video player is stopped, or the screen saver is engaged for approximately 20 minutes, the DVD video player will automatically turn itself off.

**Notes**

- Do not move the DVD video player during playback. Doing so may damage the disc.
- Use the **OPEN/CLOSE** button to open and close the disc tray. Do not push the disc tray while it is moving. Doing so may cause the DVD video player to malfunction.
- Do not push up on the disc tray or put any objects other than discs on the disc tray. Doing so may cause the DVD video player to malfunction.
- In many instances, a menu screen will appear after playback of a movie is completed. Prolonged display of an on-screen menu may damage your television set, permanently etching that image onto its screen. To avoid this, be sure to press the **STOP** button on your remote control once the movie is completed.

## Variable Speed Playback

You can play discs at various speeds, and resume playback from the location where you stopped playback.

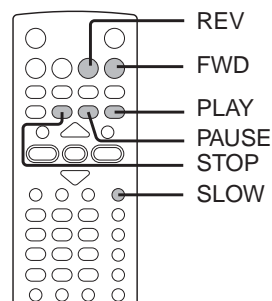

### Playing in fast reverse or fast forward directions

Press REV or FWD during playback.



REV: Fast reverse playback  
FWD: Fast forward playback

Each time you press the REV or FWD button, the playback speed changes.

#### ■ To resume normal playback

Press **PLAY**.



#### Notes

- The DVD video player mutes sound and subtitles during reverse and forward scan of DVD video discs. However, the DVD video player plays sound during fast forward or fast reverse play of audio CDs.
- The playback speed may differ depending on the disc.

### Playing frame by frame

Press PAUSE/STEP during still playback.



Each time you press the PAUSE/STEP button, the picture advances one frame.

#### ■ To resume normal playback

Press **PLAY**.



#### Note

The sound is muted during frame by frame playback.

## Playing in slow-motion

### Press SLOW during playback.

SLOW



Each time you press the SLOW button, the slow-motion speed changes in the following sequence:

▶ 1/2 → ▶ 1/4 → ▶ 1/8



▶ 1/2

### ■ To resume normal playback

Press **PLAY**.

PLAY



#### Note

- The sound is muted during slow-motion playback.
- 3 speeds are available.

## Resuming playback from the same location

### 1 Press STOP at the location where you want to interrupt playback.

STOP



The DVD video player memorizes the location where playback is stopped.

### 2 Press PLAY.

PLAY



The DVD video player resumes playback from the location where you stopped playback.

### ■ To start playback from the beginning regardless of the location where you stopped playback

1 Press **STOP** twice.

STOP





The DVD video player deletes the memory of the location.

2 Press **PLAY**.

PLAY



 Playback starts from the beginning of the current title.

 Playback starts from the beginning of the disc.

- If you want to return to the beginning of a DVD video disc, open and close the disc tray once with the OPEN/CLOSE button before pressing the PLAY button.

#### Notes

- Resuming cannot function when:
  - you change the parental lock setting .
  - you open the disc tray.
  - you disconnect the power plug of the DVD video player.
- There may be a difference in the location where playback resumes depending on the disc.
- Settings you changed using the on-screen displays while the DVD video player keeps a location in the memory may function only after the memory is cleared.

# Locating a Desired Section

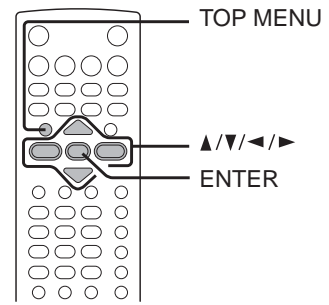

Normally, DVD video discs are divided into titles, and the titles are sub-divided into chapters. VIDEO CDs and audio CDs are divided into tracks. You can quickly locate any specific title, chapter, or track.

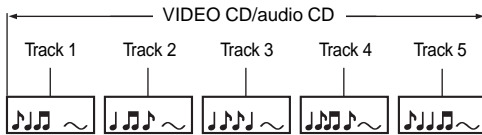
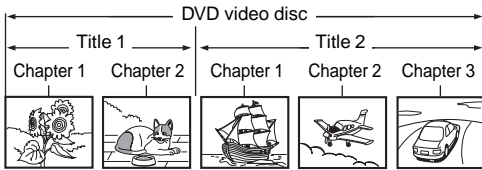

## DVD Locating a title using the top menu

### 1 Press TOP MENU.



The top menu appears on the TV screen.

e.g.

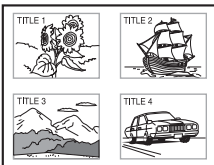

### 2 Press ▲/▼/◀/▶ to select the title you want.

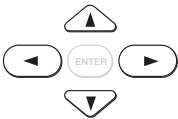

If the titles in the top menu are assigned a number, you can directly locate a specific title by pressing its designated number with the number buttons.

### 3 Press ENTER.

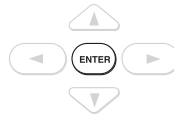

Playback starts from chapter 1 of the selected title.

#### Notes

- The instructions above describe basic procedures which may vary depending on the contents of the DVD video disc. If different instructions appear on the TV screen, follow those instructions.
- If you display the top menu during playback and press the TOP MENU button again without selecting any title, the DVD video player may resume playback from the point where you first pressed the TOP MENU button (depending on the actual DVD video disc.)
- This method of locating a title is available only on a disc that contains a top menu.
- Instruction notes of discs may refer to the button that displays the top menu as TITLE button.

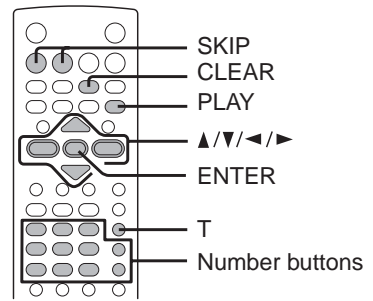

**DVD VCD CD Locating a desired section by entering the corresponding number**

**1 Press T.**  
 If you are using a VIDEO CD/audio CD, skip step 2. Then at step 3, enter the number for the track you want using the number buttons.

SEARCH T e.g. Search Time ---:--:--- Title / Chapter --- / ---

**2 Press ◀/▶ to select a section you want to locate.**

◀ ENTER ▶ e.g. When you want to locate a chapter.

SEARCH Time ---:--:--- Title / Chapter --- / ---

**3 Press ▲/▼ to enter a number of the section.**

Also the number buttons are available.  
 e.g. To enter 25

2 → 5 or +10 → +10 → 5

**4 Repeat steps 2 and 3 if necessary.**

**5 Press PLAY or ENTER.**

PLAY Playback starts from the selected section.

- Notes**
- Pressing the CLEAR button resets the numbers. To clear the display, press the T button several times.
  - This method of locating a title is available only on a disc that contains title numbers.

**DVD VCD CD Locating a specific chapter or track**

**Press SKIP ◀◀ or ▶▶ repeatedly to access the chapter or track number you want.**  
 Playback starts from the selected chapter or track.

SKIP ◀◀ ▶▶ To locate succeeding chapters or tracks.

SKIP ◀◀ ▶▶ Playback starts from the beginning of the current chapter or track. When you press twice, playback starts from the beginning of the preceding chapter or track.

- Notes**
- Some titles may not display chapter numbers.
  - If you press and hold the SKIP ◀◀ or ▶▶ button on the front panel during playback, the DVD video player performs fast reverse or fast forward playback. You can vary the speed by pressing the button repeatedly. To locate chapters or tracks during fast reverse or fast forward playback, first press the PLAY button to resume normal playback, then use the SKIP ◀◀ or ▶▶ button.

Basic playback



# Advanced playback

Customizing the performance of your DVD video player.

- **Accessing a Specific Location Directly**
- **Repeating a Specific Segment**
- **Playing in a Varied Order**
- **Playing in a Favorite Order**
- **Zooming a Picture**
- **Selecting the Picture Enhancement (E.P.M.)**
- **Selecting the Sound Enhancement (E.A.M.)**
- **Selecting the Camera Angle**
- **Selecting Subtitles**
- **Selecting a Language**
- **On-screen Display Operation**
- **Playing MP3/WMA Files**
- **Viewing JPEG Files**

## Accessing a Specific Location Directly

You can access a specific location by entering its corresponding time (hours, minutes, seconds).

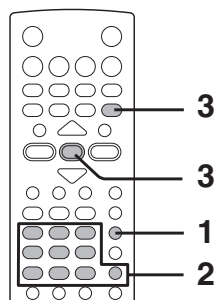

### DVD VCD CD Entering the time counter of the desired location

#### 1 Press T several times.



You may have to press further depending on the disc. Press the button repeatedly until the time counter is highlighted.

e.g.



#### 2 Press the number buttons to enter the time.

e.g.



#### 3 Press PLAY or ENTER.



Playback starts from the desired location.

#### Notes

- Some discs may not respond to this process.
- Some scenes may not be located precisely as you specified.
- This method for accessing specific locations is available only within the current title of the DVD video disc or within the current track of the VIDEO CD/audio CD.

## Repeating a Specific Segment

You can specify a desired segment and repeat it.

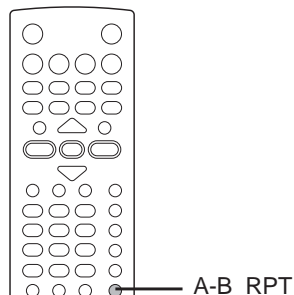

### DVD VCD CD Repeating a specific segment

#### 1 Press A-B RPT at the beginning of the segment (point A) you want to play repeatedly.



#### 2 Press A-B RPT again at the end of the segment (point B).



The DVD video player automatically returns to point A and starts repeat playback of the selected segment (A-B).

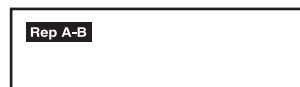

#### To resume normal playback

Press A-B RPT until **Rep off** is displayed.



#### Notes

- Some discs may not permit A-B repeat operation.
- You cannot set the A-B repeat function for a segment that includes multiple camera angles **40**.
- You can specify a segment only within the current title or track (VIDEO CD).
- There may be a slight difference between point A and the location where playback actually resumes depending on the disc.



# Playing in a Varied Order

You can play titles, chapters within a title, or tracks in a varied order.

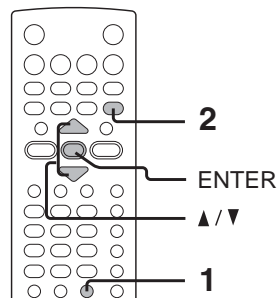

## DVD VCD CD Playing titles, chapters or tracks in a varied order

### 1 Press PLAY MODE.



Press ▲ / ▼ button to select desired features and then press ENTER button to toggle desired mode.

e.g.

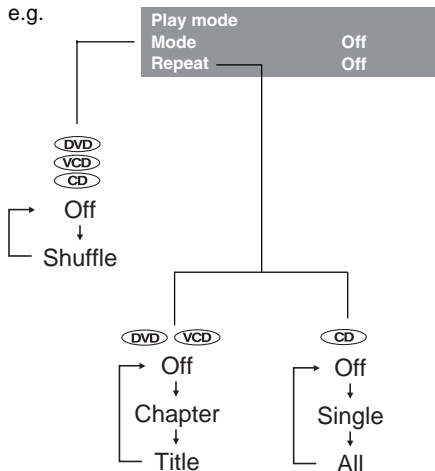

**Chapter:**

Plays the chapters within the current title in random order.

**Title:**

Repeats the current title.

**Single:**

Repeats the current track.

**All:**

Repeats the entire disc.

**Off:**

Resumes normal playback.

### 2 Press PLAY.



Press the PLAY button, the DVD video player starts playback in the selected mode.

■ **To resume normal playback**

Press **ENTER** until the **Off** is displayed.

**Note**

Some discs may not permit these operations.

Advanced playback

# Playing in a Favourite Order

You can combine your favorite titles, chapters, or tracks and play them in the order you determine. You can program up to 30 selections into the memory. (Memory playback)

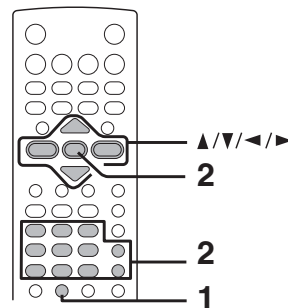

## DVD VCD CD Setting titles, chapters, or tracks in a favourite order

### 1 Insert a disc and press MEMORY during stop.



The following display appears.

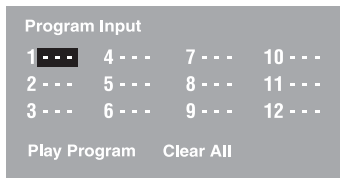
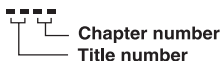
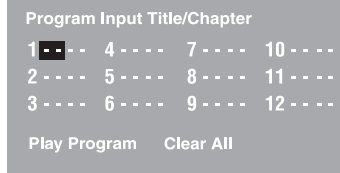

### 2 Select the items in the order you want by pressing the number buttons.

Each time you press the  $\blacktriangle/\blacktriangledown/\blacktriangleleft/\blacktriangleright$  button, the space is highlighted in turn. Highlight where you want to enter, then press the corresponding number buttons.

To select another chapter in the same title, you do not need to select the title number.

To select tracks from a VIDEO CD/audio CD in order, press the **number buttons** for the track.

### 3 Press $\blacktriangle/\blacktriangledown/\blacktriangleleft/\blacktriangleright$ to move the highlighted bar to Play Program, then press the ENTER.

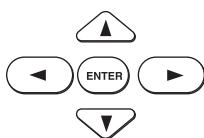

The DVD video player starts memory playback.

#### ■ To change the programmed selections

- 1 While the display appears on the TV screen, press  $\blacktriangle/\blacktriangledown/\blacktriangleleft/\blacktriangleright$  to move the highlighted bar to the item you want to change.
- 2 Change the selection following the instructions in step 2.

#### ■ To cancel the programmed selections

- 1 While the display appears on the TV screen, press  $\blacktriangle/\blacktriangledown$  to move the highlighted bar to the item you want to cancel.
- 2 Press CLEAR.

#### ■ To resume normal playback from memory playback

Press **MEMORY** button.

Press  $\blacktriangle/\blacktriangledown/\blacktriangleleft/\blacktriangleright$  to move the highlighted bar to **Clear All**, then press the **ENTER**. All the input programmes will be cleared.

Press **MEMORY** button again to resume normal playback



Normal playback will start from current location.

#### ■ To program during playback

If you press the **MEMORY** button during playback, a programming display appears. Follow steps 2 and 3.

#### Notes

- Some discs may not permit memory playback operation.
- If you press the PLAY MODE button during memory playback, the DVD video player repeats the current memory playback.
- If you press the MEMORY or RETURN button while the display appears on the TV screen, the display disappears.
- The programmed selections will be cleared when you turn off the DVD video player.

# Zooming a Picture

You can magnify areas within a picture.

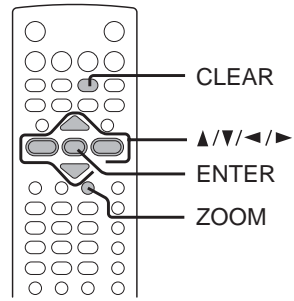
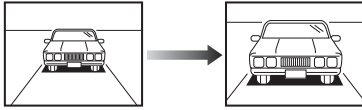

## DVD VCD Zooming a picture

### Press ZOOM during normal, slow or still playback.



The DVD video player enters the zoom playback mode and displays the icon.

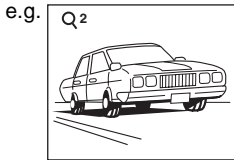

Each time you press the ZOOM button, the magnification level changes as follows:

Q 1 → Q 2 → Q 3 → Q Off

Press the ZOOM button to select the magnification level. Variation of the levels includes image reduction.

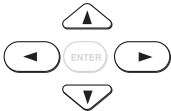

You can shift the highlight within the icon by the ▲ / ▼ / ◀ / ▶ buttons.

When you reach the edge of the image, the display will not shift anymore in that direction.



**Q off**  
Press the ZOOM button repeatedly until the Q off is displayed.

### ■ To resume normal playback

Press ZOOM repeatedly until the Q off is displayed. Original picture is restored.



#### Notes

- Some discs may not respond to zoom feature.
- During some scenes, the buttons may not work as described.
- Zooming does not work on subtitles or menus included on DVD video discs.
- While the icon is displayed, the ▲ / ▼ / ◀ / ▶ buttons cannot work on menus included on the DVD video discs. If you want to view the menus, turn off the icon.
- The magnification level varies depending on the picture size you select. **56**

## Selecting the Picture Enhancement (E.P.M.\*)

You can easily select a preferred picture enhancement.

\*E.P.M.: Enhanced Picture Mode

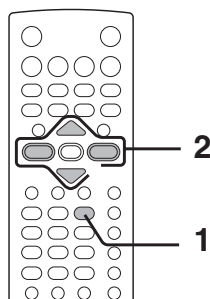

 **Selecting the picture enhancement**

**1**

**Press E.P.M.**

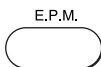

The picture enhancement menu appears.

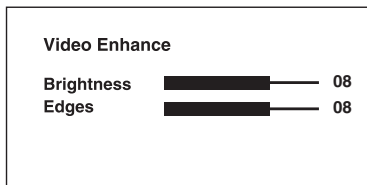

**■ To exit the picture enhancement selection**

Press E.P.M. again.

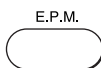

**Note**

Actual effect to picture may vary depending on the TV. Make selection according to your preference.

**2**

**Select the picture enhancement by pressing  $\blacktriangle$ / $\blacktriangledown$ , then press  $\blacktriangleleft$ / $\blacktriangleright$  to make your selections.**

Each time you press the  $\blacktriangleleft$ / $\blacktriangleright$  button, the picture enhancement changes.

## Selecting the Sound Enhancement (E.A.M. \*)

You can easily switch a preferred audio enhancement.

\*E.A.M.: Enhanced Audio Mode

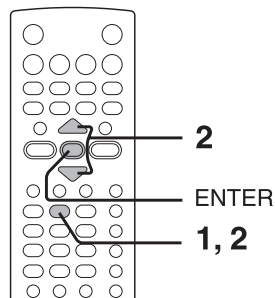

### DVD VCD Selecting the sound enhancement

#### 1 Press E.A.M.

E.A.M. The sound enhancement will appear:



Press the E.A.M. button again, the sound enhancement change to OFF.

#### 3D\*:

To obtain expansive virtual surround sound effects from two speakers.

To use this enhancement on sounds output from the ANALOG AUDIO OUT jacks, be sure to set "Digital Out" to "PCM".

\* Effective in playback of a DVD video disc or a VIDEO CD.

#### ■ To exit the audio enhancement selection

Leave the DVD video player unattended for about 5 seconds after having made a selection.

#### Notes

- Actual effects to sounds may vary depending on the speaker system. Make selection according to your preference.
- Actual effects to sounds may vary depending on the disc.
- When the DVD video player is connected to an amplifier equipped with Dolby Surround Pro Logic, select "Normal". Otherwise, Dolby Surround Pro Logic may function differently than usual.

# Selecting the Camera Angle

If the scene was recorded from multiple angles, you can easily change the camera angle of the scene you are watching.

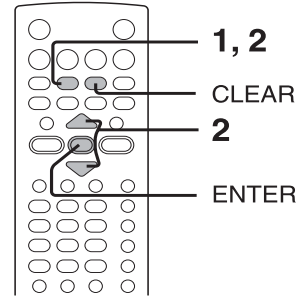
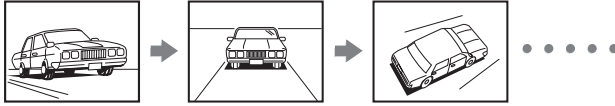

## DVD Changing the camera angle

### 1 Press ANGLE while playing a scene recorded with multiple angles.

While playing a scene recorded with multiple angles, press the ANGLE button.



e.g.



Number changes to show the number of the current angle. (The maximum number of possible angles is 9)

### 2 Press ANGLE while the angle number is displayed on the TV screen.

Press the ANGLE button repeatedly to change the scene to the next angle in those recorded.

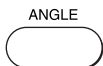

- About two seconds later, playback continues from the new angle you selected.
- If no button is pressed within 10 seconds, playback continues without changing the current angle.

### ■ To resume normal playback

Press the ANGLE repeatedly until the " 1/3 " is displayed.

### Notes:

- This function can only be used for discs on which scenes shot from multiple angles have been recorded.
- If only one angle is recorded, " 1/1 " is displayed.

# Selecting Subtitles

You can display subtitles on the TV screen and select a subtitle language from those included on the DVD video disc.

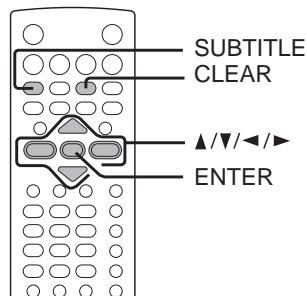

## DVD Selecting a subtitle language

### 1 Press SUBTITLE during playback.

**SUBTITLE**  
 The current subtitle setting is displayed.



### ■ To turn subtitles on or off

1 Press **SUBTITLE** during playback.



2 Press SUBTITLE repeatedly until the  Off is displayed.

### Notes

- Some DVD video discs are set to display subtitles automatically, and you cannot turn them off even if you set the subtitle function to off.
- During some scenes, the subtitles may not appear immediately after you select your desired.
- Some DVD video discs will allow you to make subtitle selections and turn subtitles on or off only via the disc menu.

### 2 Press SUBTITLE while the subtitle setting is displayed on the TV screen.

**SUBTITLE**  
 Each time you press the SUBTITLE button, the subtitle languages included on the DVD video disc change.



To turn off the subtitle setting display, press the SUBTITLE button repeatedly until  Off is displayed.

### Notes

- When you turn on the DVD video player or replace a disc, the player returns to the initial default setting .
- When you select a subtitle language which is not included on the disc, the DVD video player plays a prior language programmed on the disc.
- During some scenes, the subtitles may not appear immediately after you change the subtitle language.

## Selecting a Language

You can select a preferred language and sound recording system from those included on the DVD video disc.

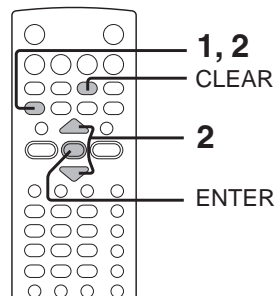
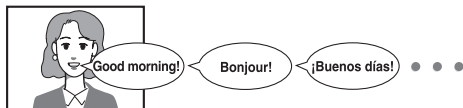

### Selecting a playback audio setting

#### 1 Press AUDIO during playback.

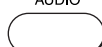
 The current audio setting is displayed.

e.g.



Recorded audio format number changes sequentially. (The maximum number of possible audio formats is 8)

The abbreviation of the language appears instead of the language name. Refer to the list of languages and their abbreviations. [59](#)

#### 2 Press AUDIO while the audio setting is displayed on the TV screen.

 Each time you press the AUDIO button, the audio settings included on the DVD video disc change.

To turn off the audio setting display, press the AUDIO button.

#### Notes

- When you turn on the DVD video player or replace a disc, player returns to the initial default setting [55](#). If you select a sound track which is not included on the disc, the DVD video player plays a prior sound track programmed on the disc.
- Some discs allow you to change audio selections only via the disc menu. If this is the case, press the MENU button and choose the appropriate language from the selections on the disc menu.

#### ■ Selecting sound channels of VIDEO CDs

Press AUDIO repeatedly during playback to hear a different audio channel (stereo, Left or Right).





## ■ Output sound conversion table

Input \ Output		COAXIAL DIGITAL AUDIO OUT Jack		ANALOG AUDIO OUT Jacks
		"Digital Out" 		
		"Raw"	"PCM"	
DVD video disc	Dolby Digital	Raw	PCM	○
	Linear PCM	PCM	PCM	○
	DTS	Raw	Raw	—
	MPEG1, MPEG2	Raw	PCM	○
VIDEO CD	MPEG1	PCM	PCM	○
Audio CD	Linear PCM 44.1 kHz/16 bit	PCM	PCM	○
	DTS	Raw	Raw	—
MP3/WMA		PCM	PCM	○

 : 3D sound enhancement can function.

- Signals of 96kHz from the COAXIAL DIGITAL AUDIO OUT jack are depressed to 48 kHz by down sampling process when:
  - "3D On" is selected. 
  - a copyright protected disc is played.
- Quantization bit of signals of 20 bit or higher which is output from the COAXIAL DIGITAL AUDIO OUT jack is 16 bit if they are in a copyright protected disc.

# On-screen Display Operation

When you turn on the on-screen display, you can view information on operational status and access features and settings.

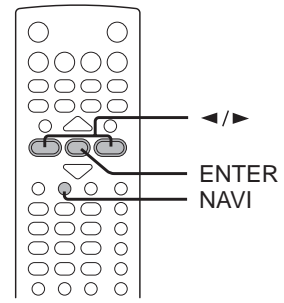

## DVD VCD CD On-screen display operation

### Press NAVI.



The following display appears.  
Each time you press the NAVI button, the on-screen display as follows.

See the pages in    for details on the features.

e.g. When playing a DVD video disc



### ■ Features

#### Title number (Track number)

Locate a title or track using the number buttons. 31

#### Chapter number

Locate a chapter using the number buttons. 31

#### Elapsed time of the current title or track

To enter the time to locate a desired location. 34

■ : To stop playback. 27

◀◀ : Playback starts from the beginning of the current chapter or track. 31

▶ : To start playback. 26

▶▶ : To locate succeeding chapters or tracks. 31

|| : To pause playback. 27

# On-screen Display Operation (Continued)

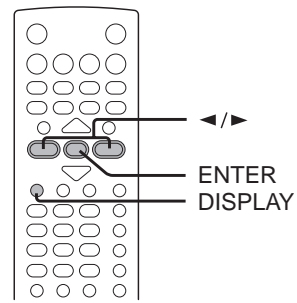

## On-screen display operation

### ■ Viewing the operational status

1 Press **DISPLAY**.

The following display appears.

Time counter

Elapsed time / remaining time of the current title

Elapsed time / remaining time of the current track

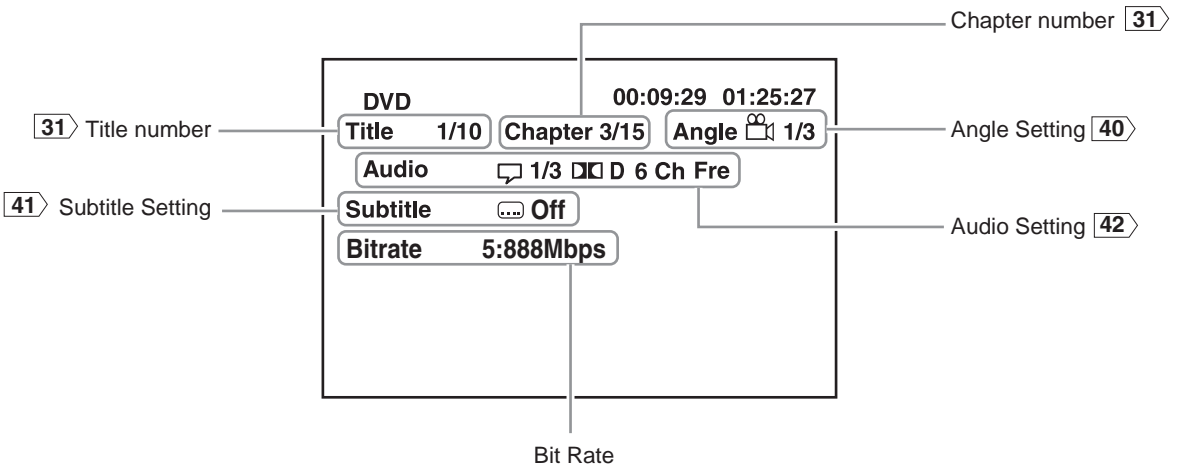

2 To turn off the display, press **DISPLAY** again.

### Bit rate (Mbit/s)

Amount of picture, sound and subtitle data in the DVD video disc transferred per second. The larger the value is, the more data processed, but this does not necessarily insure better picture quality.

## Playing MP3/WMA Files

You can play MP3/WMA files that have been recorded on a CD-R or CD-ROM on the DVD video player.

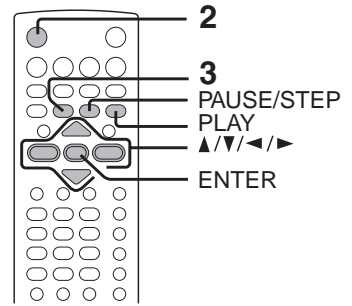

### Playing MP3/WMA files

**■ Preparations**

- Make sure that a disc you want to play is compatible with this DVD video player. **[47]**

**1 Place a CD that contains MP3/WMA files on the disc tray.**

---

**2 Press OPEN/CLOSE to load the disc.**  
 OPEN/CLOSE Playback starts.

---

**3 To stop playback, press STOP.**

**■ Selecting a track (file) in the disc**

- 1 Press **SEARCH**.
- 2 Enter the track number to select a track you want to play.
- 3 Press **ENTER** to begin playback of the selected track.  
 The current track being played is highlighted in green.

**Notes**

- You can select a track also by designating a track number. Press **SEARCH** to enter a track number, then press **ENTER** button.
- Letters of a file/folder name overflowing the given space are not displayed.
- You can not play in Fast reverse or Fast forward during MP3/WMA playback.

**■ To pause playback**

Press **PAUSE/STEP** during playback.

To resume normal playback, press the **PLAY** button.

**Notes**

- Some discs may not permit this operation.
- WMA tracks copy-protected cannot be played.
- The COAXIAL DIGITAL AUDIO OUT jack outputs MP3/WMA sounds in the linear PCM format regardless of the current "Digital Out" selection **[57]** **[43]**.
- If you stop playback by pressing the STOP button, and then press the PLAY button, playback will start from the beginning of the track.
- The SKIP **[31]** and PLAY MODE **[35]** functions are also available.

## ■ Playable files

MP3/WMA disc compatibility with this player is limited as follows:

- Playable discs: CD-ROM, CD-R (650MB / 74 min. only)  
CD-RW is not recommendable.
- Sampling Frequency: 44.1 kHz only
- Bit rate: WMA: 48 kbps - 192 kbps (CBR)  
MP3: 32 kbps - 320 kbps (CBR)
- CD physical format: Mode 1, Mode 2 XA Form 1
- File system: ISO9660 Level 1, 2 or Joliet
- File name: A file name should be in alphabet and numerals only, and must incorporate "MP3" or "WMA" extension.  
e.g. "\*\*\*\*\*.MP3", "\*\*\*\*\*.WMA"
- Total number of folders: Less than 256
- Total number of files: Less than 1000
- WMA codec version: V7 or V8 (Stereo sound only)

This DVD video player requires discs/recordings to meet certain technical standards in order to achieve optimal playback quality. Pre-recorded DVDs are automatically set to these standards. There are many different types of recordable disc formats (including CD-R containing MP3/WMA files). Given the fact that technology in this area is still maturing, Toshiba cannot guarantee that all genre of recordable discs will produce optimal playback quality. The technical criteria set out in this owner's manual are meant as a guide only.

Customers should also note that permission is required in order to download MP3 files and music from the internet. Toshiba has no right to grant such permission. Permission should always be sought from the copyright owner.

Microsoft, Windows Media, and the Windows Logo are trademarks or registered trademarks of Microsoft Corporation in both the United States and other countries.



# Viewing JPEG Files

You can play JPEG files that have been recorded on a CD-R or CD-ROM on the DVD video player.

You can select a preferred view: a page of 9 thumbnail images or a single image view.

Also, rotating, enlarging and shifting of each image can be possible.

## Starting from a thumbnail view

### ■ Preparations

- Prepare a disc that contains JPEG files you want to view. **50**
- Make your TV shape conform to the 4:3 picture size. Only 4:3 pictures can be played regardless of the function settings via the on-screen displays of the DVD video player. If the TV is adjusted to other sizes, e.g. "WIDE," images will appear to be horizontally expanded. For details, refer to the owner's manual of your TV.

### 1 Press OPEN/CLOSE to open the disc tray, place a disc that contains JPEG files.

**OPEN/CLOSE** Press OPEN/CLOSE to close the disc tray, after completion of reading, playback automatically starts. The next picture will automatically display after a few seconds.

A view appears. (Automatic mode) e.g.

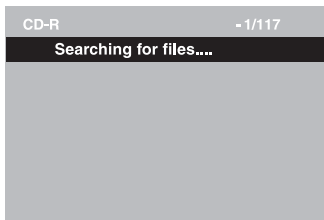

A list of folders in the disc appears. (Selection mode) e.g.

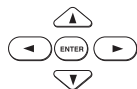
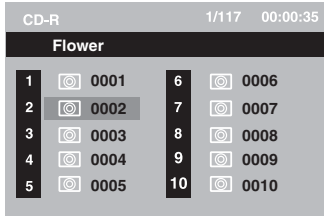

Press **▲/▼/◀/▶** to select your desired file, and then press **ENTER** or **PLAY** button to start playback.



Press **SEARCH** and enter the track number to quickly select your image.

e.g.

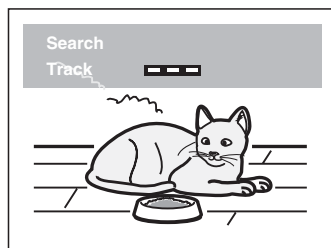

### ■ To quit the JPEG playback, press STOP.

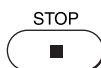

- Pressing the OPEN/CLOSE button to open the disc tray can also quit the playback.

### ■ To pause playback

Press **PAUSE/STEP** during playback



To resume normal playback, press **PLAY**.

### ■ To change the image

To view the succeeding image, press **SKIP** **▶▶**.

To view the previous image, press **SKIP** **◀◀**.

### ■ To magnify image

Press **ZOOM** repeatedly.



Each time you press the **ZOOM** button, the magnification level changes as follows: **Q 1** → **Q 2** → **Q 3** → **Q off**

Variation of the levels includes image reduction. You can shift the highlight within the icon by the **▲/▼/◀/▶** buttons. When you reach the edge of the image, the display will not shift anymore in that direction.

### ■ To rotate an image

Press the **ANGLE** repeatedly

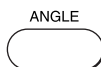

The image rotates by clockwise 90-degree.

### ■ To resume normal playback

Press the **ZOOM** repeatedly until the **Q off** is displayed.



- Original picture is restored when the icon disappears.
- Some files may not display their own entire depending on the size.

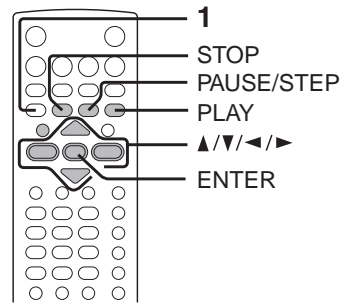

## Viewing a thumbnail view

### 1 Press TOP MENU in full-screen review.

TOP MENU



e.g.



To view the previous 9 images.

To view the succeeding 9 images.

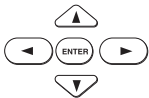

Press the ▲ / ▼ / ◀ / ▶ to select an image, press PLAY to view one image in full-screen and automatically images will be displayed one by one again in a few seconds.

### ■ Turn the page if necessary

Press ▲ / ▼ / ◀ / ▶ to highlight the PREV ◀◀ or ▶▶ NEXT and ENTER to review other thumbnail screen.

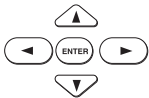

### ■ To quit the JPEG playback, press STOP.



- Pressing the OPEN/CLOSE button to open the disc tray can also quit the playback.

### ■ To pause playback

Press PAUSE/STEP during playback



To resume normal playback, press PLAY.

#### Notes

- Some files may not display their own entire depending on the size.
- If you press the TOP MENU in full-screen review, the DVD video player will display a menu of 9 thumbnail images.

## JPEG files compatibility

Discs whose compatibility with this DVD video player has been confirmed by TOSHIBA are as follows.

Many of these discs, when loaded, will make the DVD video player enter the automatic mode **48** to play a prescribed folder in the disc. To play other folders, display a folder list and select a folder.

CANON QuickCD

FUJICOLOR CD

Kodak Picture CD

NORITSU QSS CD

JPEG disc compatibility with this DVD video player is limited as follows:

- Playable discs: CD-ROM, CD-R (650MB / 74 min. only)  
CD-RW is not recommendable.
- CD physical format: Mode 1, Mode 2 XA Form 1
- File system: ISO9660 Level 1, 2 or Joliet
- File name: A file name should be in alphabet and numerals only, and must incorporate "JPG" extension.  
e.g. "\*\*\*\*\*.JPG"
- Total number of folders: Less than 256
- Total number of files: Less than 1000

Some files may not display their own entire image depending on the size.

Some discs may not permit this operation. Especially, the following conditions of included files will increase the disc's disability.

1. Pixels over 3072 x 2048 in height and/or width
2. File format except Exif



# Function setup

You can change the default settings to customize performance to your preference.

- **Customizing the Function Settings**
- **Table of Languages**

# Customizing the Function Settings

You can change the default settings to customize performance to your preference.

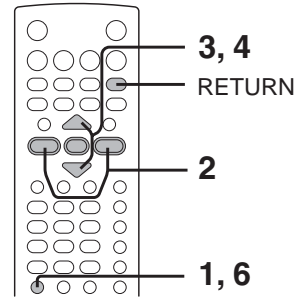

 **Setting procedure**

## 1 Press SETUP during stop.



The following on-screen display appears.

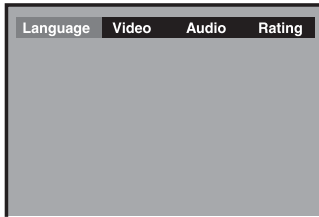

## 2 Press ◀/▶ to select a symbol for the setting you want to change, then press ENTER.

(See the next page.)

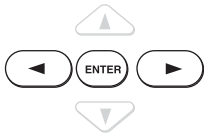

**Language settings**

**Video settings**

**Audio settings**

**Rating settings**

## 3 Press ▲/▼ to select the setting you want to change, then press ENTER.

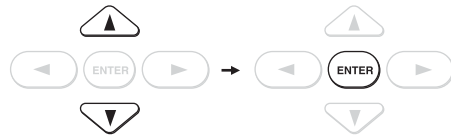

## 4 Change the selection by ▲/▼ buttons, by referring to the corresponding pages (54 -), then press ENTER.

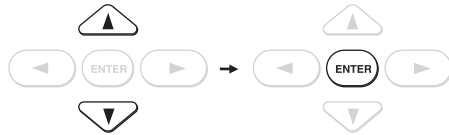

## 5 Repeat steps 3 and 4 to change other settings.

To select another operation, go back to step 2.

## 6 Press SETUP.







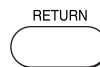











The on-screen display disappears.

- To return to the previous display Press RETURN.



**Notes**

- To quit the procedure, press the SETUP button to turn off the on-screen display.

	Setting		Details	Page
<b>Language</b>	OSD Menu	  	To select a preferred language for on-screen display.	54
	Subtitle		To select a preferred language for subtitles.	54
	Audio		To select a preferred language for the sound track.	55
	DVD Menu		To select a preferred language for disc menus.	55
<b>Video</b>	TV Shape	 	To select a picture size according to aspect ratio of your TV.	56
	TV System		To select the video system of a disc.	56
	Video Output		To select whether you send CVBS, YUV and RGB signals to the connected TV or not.	56
<b>Audio</b>	Digital Output	  	To select an output sound format corresponding to your system connection.	57
<b>Rating</b>	Password		To create a personal security code.	57
	Rating		To turn the parental lock function on or off.	58
	Load Factory		To return the initial language setting to the factory default.	58

# Customizing the Function Settings (continued)

## Setting details

### Language

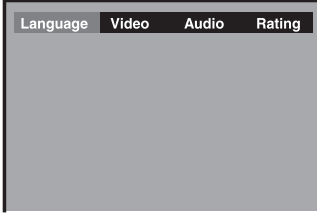

### OSD Menu



English: To view on-screen displays in English.  
 Deutsch: To view on-screen displays in German.  
 Français: To view on-screen displays in French.  
 Español: To view on-screen displays in Spanish.  
 Italiano: To view on-screen displays in Italian.

- 1) Press ENTER.
- 2) Press ▲ / ▼ to select the OSD Menu.
- 3) Press ENTER button, then the ▲ / ▼ to shift and change the Language.
- 4) Press ENTER.
- 5) Press RETURN.



**Note**  
 Some DVD video discs may not include your pre-selected language. In this case, the DVD video player automatically displays disc menus consistent with the disc's initial language setting.

### Subtitle



English: To display subtitles in English.  
 Deutsch: To display subtitles in German.  
 Français: To display subtitles in French.  
 Español: To display subtitles in Spanish.  
 Italiano: To display subtitles in Italian.  
 Auto: To display subtitles in different languages other than you selected.  
 Off: To disable subtitles.

- 1) Press ENTER.
- 2) Press ▲ / ▼ to select the Subtitle.
- 3) Press ENTER button, then the ▲ / ▼ to shift and change the Language.
- 4) Press ENTER.
- 5) Press RETURN.

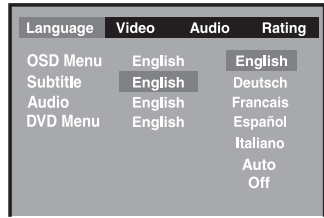

### Notes

- Some DVD video discs may be set to display subtitles in a different language other than you selected. A prior subtitle language may be programmed on the disc.
- Some DVD video discs allow you to change subtitle selections only via the disc menu. If this is the case, press the MENU button and choose the appropriate subtitle language from the selection on the disc menu.

**Audio**

English: To play sound tracks in English.  
 Deutsch: To play sound tracks in German.  
 Français: To play sound tracks in French.  
 Español: To play sound tracks in Spanish.  
 Italiano: To play sound tracks in Italian.

- 1) Press ENTER.
- 2) Press ▲ / ▼ to select the AUDIO.
- 3) Press ENTER button, then the ▲ / ▼ to shift and change the Language.
- 4) Press ENTER.
- 5) Press RETURN.

Language	Video	Audio	Rating
OSD Menu	English	English	
Subtitle	English	Deutsch	
Audio	English	Francais	
DVD Menu	English	Español	
		Italiano	

**Note**

Some DVD video discs may not be played in a different language than you selected. A prior language may be programmed on the disc.

**DVD Menu**

English: To display DVD menus in English.  
 Deutsch: To display DVD menus in German.  
 Français: To display DVD menus in French.  
 Español: To display DVD menus in Spanish.  
 Italiano: To display DVD menus in Italian.

- 1) Press ENTER.
- 2) Press ▲ / ▼ to select the DVD menu.
- 3) Press ENTER button, then the ▲ / ▼ to shift and change the Language.
- 4) Press ENTER.
- 5) Press RETURN.

Language	Video	Audio	Rating
OSD Menu	English	English	
Subtitle	English	Deutsch	
Audio	English	Francais	
DVD Menu	English	Español	
		Italiano	

**Note**

Some DVD video discs may not include your pre-selected language. In this case, the DVD video player automatically displays disc menus consistent with the disc's initial language setting.

## Customizing the Function Settings (continued)

### Setting details

#### Video

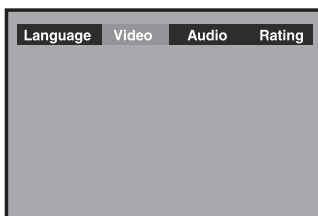

#### TV Shape (DVD)

- 1) Press ◀/▶ to select the Video.
- 2) Press ENTER.
- 3) Press ENTER button, then press the ▲/▼ to shift and change the TV type
- 4) Press ENTER.
- 5) Press RETURN.

**4:3 Pan Scan:** Select when a standard 4:3 TV is connected.



Displays pictures cropped to fill your TV screen. Either or both sides of the picture are cut off.

**4:3 Letterbox:** Select when a standard 4:3 TV is connected.

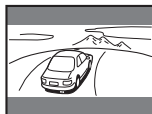

Displays theatrical images with masking bars above and below the picture.

**16:9 Widescreen:** Select when a 16:9 wide TV is connected.

#### Notes

- The displayable picture size is preset on the DVD video disc. Therefore, the playback picture of some DVD video discs may not conform to the picture size you select.
- When you play DVD video discs recorded in the 4:3 picture size only, the playback picture always appears in the 4:3 picture size regardless of the TV shape setting.
- If you select "16:9 Widescreen" and you own a 4:3 TV set, the DVD playback picture will be horizontally distorted during playback. Images will appear to be horizontally compressed. Always be sure that your TV shape conforms to the actual TV in use.

#### TV System (DVD) (VCD)

- 1) Press ◀/▶ to select the Video.
- 2) Press ENTER.
- 3) Press ▲/▼ to select the TV system.
- 4) Press ENTER button, then press ▲/▼ to shift and change the Video system.
- 5) Press ENTER.
- 6) Press RETURN.

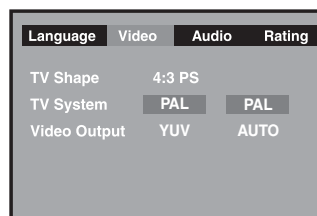

**NTSC:** Select if your TV system is NTSC.

**PAL:** To play a PAL disc. Connect a PAL TV to view a picture.

**Auto:** The DVD video player automatically identifies PAL or NTSC video system of a disc. Connect a multisystem TV (PAL/NTSC compatible) to view a picture.

A playback picture may be distorted when detected a signal change between PAL and NTSC on the disc.

For the case of Progressive mode, your multisystem TV must be able to support 525p and 625p.

#### Video Output (DVD) (VCD)

- 1) Press ◀/▶ to select the Video.
- 2) Press ENTER.
- 3) Press ▲/▼ to select the Video Output.
- 4) Press ENTER button, then press ▲/▼ to shift and change the Progressive Signal.
- 5) Press ENTER.
- 6) Press RETURN.

**CVBS:** Select if you connect the DVD to TV via SCART cable or composite video input.

**YUV:** Corresponding to your TV which has a YUV (component video) inputs. Progressive mode can only be on when YUV is selected.

**RGB:** Select if you connect the DVD to TV via SCART cable.

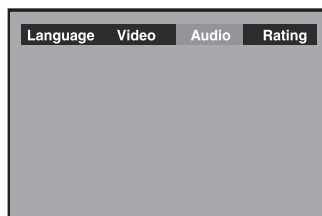
**Audio****Digital Out**

DVD VCD CD

Selected the output sound format corresponding to your system connection.

- 1) Press ◀/▶ to select Audio.
- 2) Press ENTER.
- 3) Press ENTER button, then press ▲/▼ to shift and change the output sound format.

PCM: Select when connected to a 2 channel digital stereo amplifier.

The DVD video player outputs sounds in the PCM 2 channel format when you play a DVD video disc recorded on the Dolby Digital, MPEG1 OR MPEG2 recording system.

Raw: Does not have a Dolby Digital Decode.

**Note**

When you make a connection to a TV, or Dolby Surround Pro Logic or stereo system via the analog audio jacks, select "PCM" or "Raw".

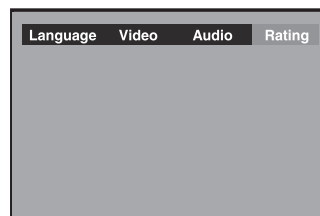
**Rating****Password / Parental lock**

DVD

DVD discs equipped with the password function are rated according to their content. The contents allowed by a parental lock level and the way a DVD disc can be controlled may vary from disc to disc.

For example, if the disc allowed, you could edit out violent scenes unsuitable for children and replace them with more suitable scenes, or you could lock out playback of the disc altogether.

- DVD video discs may or may not respond to the parental lock settings. This is not a defect in the DVD video player. Make sure this function works with your DVD video discs.
- 1) Press ◀/▶ to select the Rating.
  - 2) Press ENTER.
  - 3) Press ▲/▼ to select Rating and then press ENTER repeatedly to set the parental lock level.
  - 4) Press ▲ to the Password and enter your 4-digits security code, then press ENTER button.
  - 5) Press RETURN.

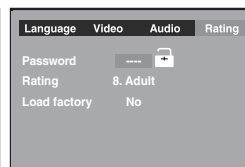
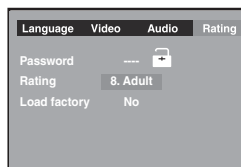
**Notes**

- If you make a mistake before pressing ENTER button, press CLEAR button and enter your 4-digit security code again.
- You cannot play DVD discs rated higher than the level you selected unless you cancel the parental lock function.

(continued)

## Customizing the Function Settings (continued)

### Setting details

(continued)

The parental lock level is equivalent to the following ratings:

- Level 1: Kid Safe
- Level 2: G
- Level 3: PG
- Level 4: PG-13
- Level 5: PG-R
- Level 6: R
- Level 7: NC-17
- Level 8: Adult



Indicates Parental lock is not active.



The Parental lock is active.

**If you forget the password, you can erase your current password by pressing number button on the remote four times, then press ENTER button to confirm the setting.**

**PASSWORD: 8888**

### Load factory

DVD VCD CD

If you want to return the initial language setting to the factory default, do the following:

- 1) Press ▲/▼ to select the Load factory.
- 2) Press ENTER.
- 3) Press ▲/▼ to select Yes, then press ENTER button.
- 4) Press ENTER.

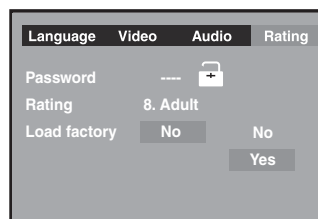

#### Note

When you reset the DVD video player to the factory default, the DVD video player will take 3-5 seconds to reset.



# Table of Languages

**Table of languages and their abbreviations**

Abbreviation	Language	Abbreviation	Language	Abbreviation	Language
---	No alternate language	GN	Guarani	PT	Portuguese
CHI (ZH)	Chinese	GU	Gujarati	QU	Quechua
DUT (NL)	Dutch	HA	Hausa	RM	Rhaeto-Romance
ENG (EN)	English	HI	Hindi	RN	Kirundi
FRE (FR)	French	HR	Croatian	RO	Rumanian
GER (DE)	German	HU	Hungarian	RU	Russian
ITA (IT)	Italian	HY	Armenian	RW	Kinyarwanda
JPN (JA)	Japanese	IA	Interlingua	SA	Sanskrit
KOR (KO)	Korean	IE	Interlingue	SD	Sindhi
MAY (MS)	Malay	IK	Inupiak	SG	Sango
SPA (ES)	Spanish	IN	Indonesian	SH	Serbo-Croatian
AA	Afar	IS	Icelandic	SI	Singhalese
AB	Abkhazian	IW	Hebrew	SK	Slovak
AF	Afrikaans	JI	Yiddish	SL	Slovenian
AM	Amharic	JW	Javanese	SM	Samoan
AR	Arabic	KA	Georgian	SN	Shona
AS	Assamese	KK	Kazakh	SO	Somali
AY	Aymara	KL	Greenlandic	SQ	Albanian
AZ	Azerbaijani	KM	Cambodian	SR	Serbian
BA	Bashkir	KN	Kannada	SS	Siswati
BE	Belorussian	KS	Kashmiri	ST	Sesotho
BG	Bulgarian	KU	Kurdish	SU	Sundanese
BH	Bihari	KY	Kirghiz	SV	Swedish
BI	Bislama	LA	Latin	SW	Swahili
BN	Bengali, Bangla	LN	Lingala	TA	Tamil
BO	Tibetan	LO	Laotian	TE	Telugu
BR	Breton	LT	Lithuanian	TG	Tajik
CA	Catalan	LV	Latvian, Lettish	TH	Thai
CO	Corsican	MG	Malagasy	TI	Tigrinya
CS	Czech	MI	Maori	TK	Turkmen
CY	Welsh	MK	Macedonian	TL	Tagalog
DA	Danish	ML	Malayalam	TN	Setswana
DZ	Bhutani	MN	Mongolian	TO	Tongan
EL	Greek	MO	Moldavian	TR	Turkish
EO	Esperanto	MR	Marathi	TS	Tsonga
ET	Estonian	MT	Maltese	TT	Tatar
EU	Basque	MY	Burmese	TW	Twi
FA	Persian	NA	Nauru	UK	Ukrainian
FI	Finnish	NE	Nepali	UR	Urdu
FJ	Fiji	NO	Norwegian	UZ	Uzbek
FO	Faroese	OC	Occitan	VI	Vietnamese
FY	Frisian	OM	(Afan) Oromo	VO	Volapük
GA	Irish	OR	Oriya	WO	Wolof
GD	Scottish Gaelic	PA	Panjabi	XH	Xhosa
GL	Galician	PL	Polish	YO	Yoruba
		PS	Pashto, Pushto	ZU	Zulu

# Others

- **Before Calling Service Personnel**
- **Specifications**

## Before Calling Service Personnel

Check the following guide for the possible cause of a problem before contacting service.

### Symptoms and correction

Symptom	Cause	Correction	Page
No power.	<ul style="list-style-type: none"> <li>The power plug is disconnected.</li> </ul>	<ul style="list-style-type: none"> <li>Connect the power plug securely into the wall outlet.</li> </ul>	<b>18</b>
The DVD video player turned off by itself.	<ul style="list-style-type: none"> <li>The automatic power off function turned the unit off.</li> </ul>	<ul style="list-style-type: none"> <li>Press the PLAY button.</li> </ul>	<b>27</b>
No picture.	<ul style="list-style-type: none"> <li>The TV is not set to receive DVD signal output.</li> </ul>	<ul style="list-style-type: none"> <li>Select the appropriate video input mode on the TV so the picture from the DVD video player appears on the TV screen.</li> </ul>	<b>26</b>
	<ul style="list-style-type: none"> <li>The video cable is not connected securely.</li> </ul>	<ul style="list-style-type: none"> <li>Connect the video cable securely into the appropriate jacks.</li> </ul>	<b>18, 19</b>
No sound.	<ul style="list-style-type: none"> <li>The equipment connected with the audio cable is not set to receive DVD signal output.</li> </ul>	<ul style="list-style-type: none"> <li>Select the correct input mode of the audio receiver so you can listen to the sound from the DVD video player.</li> </ul>	<b>26</b>
	<ul style="list-style-type: none"> <li>The audio cable is not connected securely.</li> </ul>	<ul style="list-style-type: none"> <li>Connect the audio cable securely into the appropriate jacks.</li> </ul>	<b>18 – 23</b>
	<ul style="list-style-type: none"> <li>The audio receiver or TV is turned off.</li> </ul>	<ul style="list-style-type: none"> <li>Turn on the equipment connected with the audio cable.</li> </ul>	<b>26</b>
	<ul style="list-style-type: none"> <li>The setting of output sound format is incorrect.</li> </ul>	<ul style="list-style-type: none"> <li>Select the proper audio setting.</li> </ul>	<b>43, 52 57</b>
The playback picture has occasional distortion.	<ul style="list-style-type: none"> <li>The disc is dirty.</li> </ul>	<ul style="list-style-type: none"> <li>Eject the disc and clean it.</li> </ul>	<b>9</b>
	<ul style="list-style-type: none"> <li>It is in fast forward or fast reverse playback.</li> </ul>	<ul style="list-style-type: none"> <li>Sometimes a small amount of picture distortion may appear. This is not a malfunction.</li> </ul>	–
Brightness is unstable or noises are present in the playback pictures.	<ul style="list-style-type: none"> <li>The effect of copy protection.</li> </ul>	<ul style="list-style-type: none"> <li>Connect the DVD video player directly to the TV. Avoid connecting the DVD video player to a VCR or TV/VCR combination.</li> </ul>	<b>18</b>
Abnormal colour appeared on logo screen.	<ul style="list-style-type: none"> <li>Mismatch setting between TV and this unit.</li> </ul>	<ul style="list-style-type: none"> <li>Select the correct Video Output setting.</li> </ul>	<b>56</b>
	<ul style="list-style-type: none"> <li>Wrong connection.</li> </ul>	<ul style="list-style-type: none"> <li>Check the connection.</li> </ul>	<b>19</b>
The DVD video player does not start playback.	<ul style="list-style-type: none"> <li>No disc is inserted.</li> </ul>	<ul style="list-style-type: none"> <li>Insert a disc.</li> </ul>	<b>26</b>
	<ul style="list-style-type: none"> <li>An unplayable disc is inserted.</li> </ul>	<ul style="list-style-type: none"> <li>Insert a playable disc. (Check the disc type and color system.)</li> </ul>	<b>10</b>
	<ul style="list-style-type: none"> <li>The disc is placed upside down.</li> </ul>	<ul style="list-style-type: none"> <li>Place the disc with the playback side down.</li> </ul>	<b>26</b>
	<ul style="list-style-type: none"> <li>The disc is not placed within the guide.</li> </ul>	<ul style="list-style-type: none"> <li>Place the disc correctly inside the guide on the disc tray.</li> </ul>	<b>26</b>
	<ul style="list-style-type: none"> <li>The disc is dirty.</li> </ul>	<ul style="list-style-type: none"> <li>Clean the disc.</li> </ul>	<b>9</b>
	<ul style="list-style-type: none"> <li>The parental lock function is set.</li> </ul>	<ul style="list-style-type: none"> <li>Cancel the parental lock function or change the parental lock level.</li> </ul>	<b>52, 57</b>
Playback does not follow the course of the disc's program.	<ul style="list-style-type: none"> <li>It is in the mode of repeat playback, memory playback, etc.</li> </ul>	<ul style="list-style-type: none"> <li>These operations may prevent a proper progress of the contents.</li> </ul>	–
Buttons do not work.	<ul style="list-style-type: none"> <li>Power supply fluctuations or other abnormalities such as static electricity may interrupt correct operations.</li> </ul>	<ul style="list-style-type: none"> <li>Press and hold the ON/STANDBY button on the front panel for more than about 3 seconds. The DVD video player turns off. Press the button again to turn it on. If the buttons still do not work, disconnect the power plug and insert it into the wall outlet again.</li> </ul>	–
The remote control does not work properly.	<ul style="list-style-type: none"> <li>The remote control is not pointed at the remote sensor of the DVD video player.</li> </ul>	<ul style="list-style-type: none"> <li>Point the remote control at the remote sensor of the DVD video player.</li> </ul>	<b>15</b>
	<ul style="list-style-type: none"> <li>The remote control is too far from the DVD video player.</li> </ul>	<ul style="list-style-type: none"> <li>Operate the remote control within about 7 m.</li> </ul>	<b>15</b>
	<ul style="list-style-type: none"> <li>The batteries in the remote control are exhausted.</li> </ul>	<ul style="list-style-type: none"> <li>Replace the batteries with new ones.</li> </ul>	<b>15</b>

## DVD video player / outputs / supplied accessories

### DVD Video Player

Power supply	100 - 240 V AC, 50/60 Hz
Power consumption	13 W
Mass	2.2 kg
External dimensions	430 x 50 x 200 mm (W/H/D)
Signal system	PAL/3.58 NTSC
Laser	Semiconductor laser, wavelength 650/780 nm
Frequency range	DVD linear sound : 48 kHz sampling 4 Hz to 22 kHz 96 kHz sampling 4 Hz to 44 kHz
Signal-to-noise ratio	More than 100 dB
Audio dynamic range	More than 93 dB
Harmonic distortion	Less than 0.005 %
Wow and flutter	Below measurable level (less than $\pm 0.001$ % (W.PEAK))
Operating conditions	Temperature: 5 °C to 35 °C, Operation status: Horizontal

### Outputs

Video output (SCART)	1.0 V (p-p), 75 $\Omega$ , SCART socket x 1
Video output (Phone type)	1.0 V (p-p), 75 $\Omega$ , negative sync., pin jack x 1
Component video output	(Y) 1.0 V (p-p), 75 $\Omega$ , negative sync., pin jack x 1 (P <sub>B</sub> )/(P <sub>R</sub> ) 0.7 V (p-p), 75 $\Omega$ , pin jack x 2
Audio output (COAXIAL DIGITAL)	0.5 V (p-p), 75 $\Omega$ , pin jack x 1
Audio output (ANALOG)	2.0 V (rms), 680 $\Omega$ , pin jacks (L, R) x 1

### Supplied Accessories

Remote control (SE-R0127) .....	1
Batteries (R03) .....	2
Power cord .....	1

- Designs and specifications are subject to change without notice.

**TOSHIBA**

Printed in China  
811-SD39A1-050